

## NOVA COMFORT STANDARD

### I. Allmän Monteringsmanual

# Läs detta innan du monterar ditt Nova pooltak !

## **Underlag / Installation på trädäck**

Det är av yttersta vikt att underlaget är stabilt och jämnt för att taket skall fungera felfritt. Vi rekommenderar att lägga extra regler (kottlingar) där skenan ska vara. Detta för att säkerställa extra stabilitet under skenan.

Säkerställ att måttet är korrekt mellan skenorna annars kommer taket inte fungera optimalt utan blir svårt att öppna och stänga. För exakta mått för just ditt boxtak se Modell specifik manual.

## **Öppna pallen**

Var uppmärksam så att den öppnas från rätt håll för att undvika onödiga skador. Långsidan som är skruvad skall öppnas enligt markeringar på pallen.

## **Skruvarna**

Dessa ska fettas in före montering för att undvika skador på gänga eller brott på skruv. Universalfett går utmärkt att använda.

## **Skyddsplast på panelerna**

Skyddsplasten skall avlägsnas innan montage. Tänk på att inte utsätta panelerna för solljus när skyddsplasten sitter kvar då detta kan orsaka att skyddsplasten "bränner fast" i panelen.

## **Gummilister**

Tänk på att dessa krymper lite över tid, dra aldrig i dem vid montering utan "mata/tryck" snarare på lite extra. Panelens gummilist kan eventuellt glida ur aluminiumprofilen pga. termisk expansion. Om detta händer så spraya med fönsterputs och tryck tillbaka gummilisten

## **OBS!**

Innan ni börjar montera ert nya pooltak så rekommenderar vi att ni går in på vår hemsida och tittar på vår monteringsfilm.



# Användarmanual och underhåll

## Snöbärighet

Vid kraftigt snöfall måste snön tas bort från pooltaken, tänk på att blötsnö väger mycket och kan deformera pooltakets aluminiumkonstruktion. Gullberg och Janssons pooltak är godkända enligt standarden (NF P90-309) och är testade för 45kg/m<sup>2</sup> vikt.

## Vind och barnsäkerhet

Våra tak är testade enligt AFNOR NF P 90309 standarden gällande vind och barnsäkerhet. Dörren måste vara låst.

## Ytrost

Detta omfattas inte av garantin då det inte påverkar takets konstruktion eller funktion. Ytrost på fästelement av rostfritt stål (A2, 1.4301) kan uppkomma av felaktiga vattenvärden i poolen eller t ex aggressiva rengöringsmedel. Tips! Prova att avlägsna med en mjuk trasa och flytande rengöringsmedel (utan slipmedel).

## Skenorna

Måste hållas rena från skräp (sand, grus, löv och grenar).

## Panelerna

Ska endast rengöras med rent vatten. Använd ej högtryckstvätt, borstar, svampar eller rengöringsmedel med slipmedel.

## Rörliga delar

Såsom lås, fjäder etc. kan med fördel behandlas med t ex WD40 före och efter säsongen.

## Pooltaket

Ska öppnas och stängas med försiktighet, bromsa in vid varje automatisk låsning eftersom delarna är gjorda för att positionera och fixera sektionerna inte bromsa och stoppa sektionerna. Skenlåsen är slitagedelar och kan behövas bytas efter några år.

**OBS!** Kontakta alltid ditt försäkringsbolag för att säkerställa vad som gäller om det skulle ske en yttre påverkan på just ditt pooltak.

Skador som uppkommer pga. att ovanstående instruktioner inte följs omfattas inte av garantin.

**Vänligen kontakta alltid din återförsäljare vid garantiärende eller frågor**

---

Nova Comfort Standard 4,5x10,5	A4/5
Nova Comfort Standard 4x8	A4M
Nova Comfort Standard 4,5x8,5	A4
Nova Comfort Standard 3x6	A3M
Nova Comfort Standard 3,5x6,5	A3
Nova Comfort Standard 4x7,5	A4S

# URLASTNING BOX

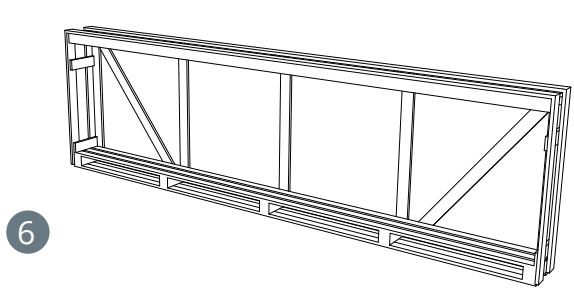
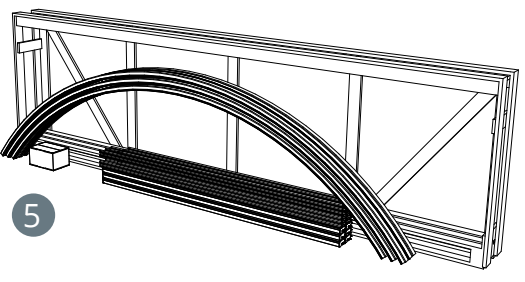
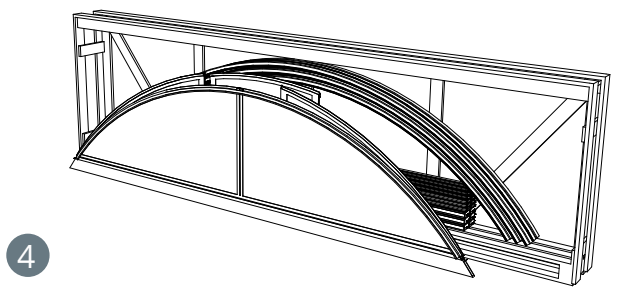
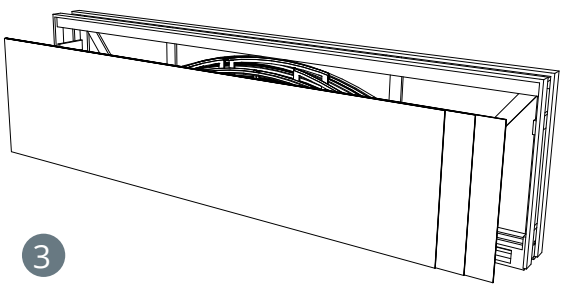
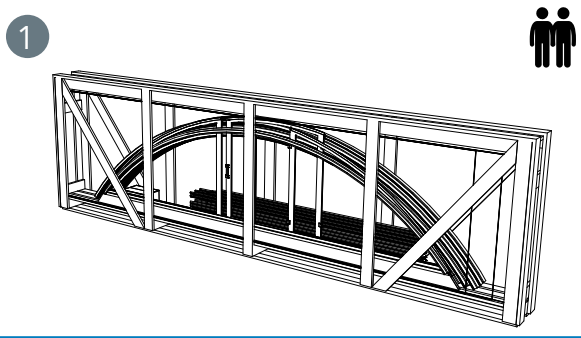
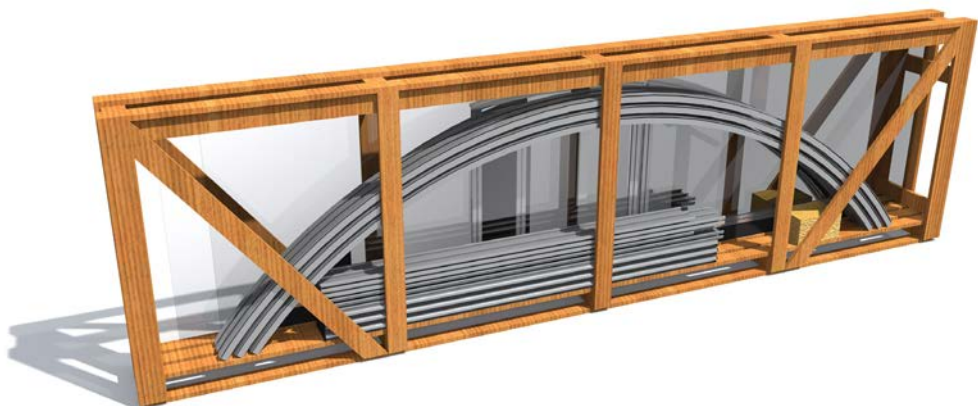

# URLASTNING BOX

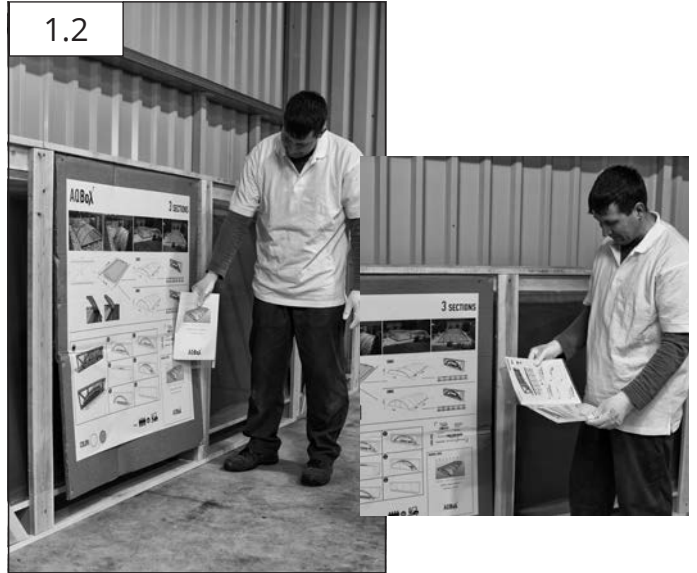

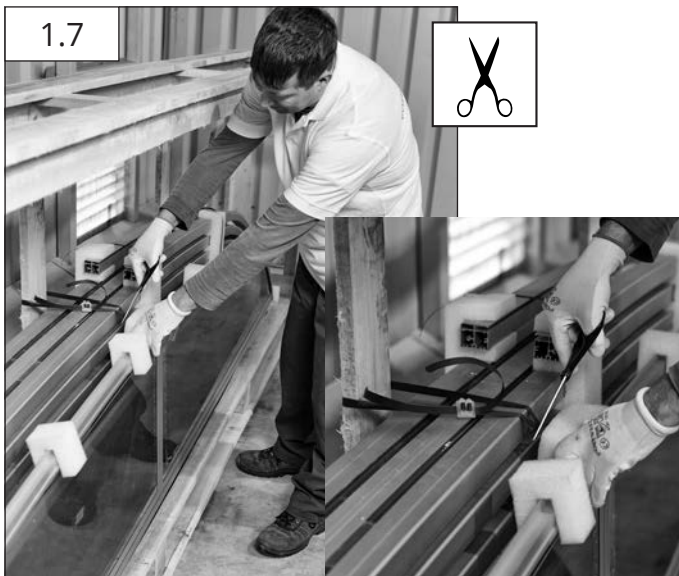

Rekommenderade verktyg (ingår ej)

## 2 MONTERING SKENOR

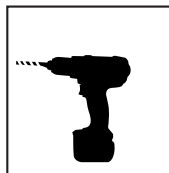
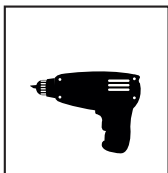
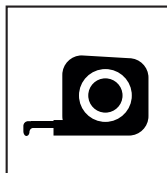
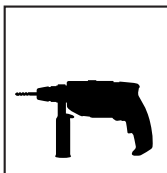
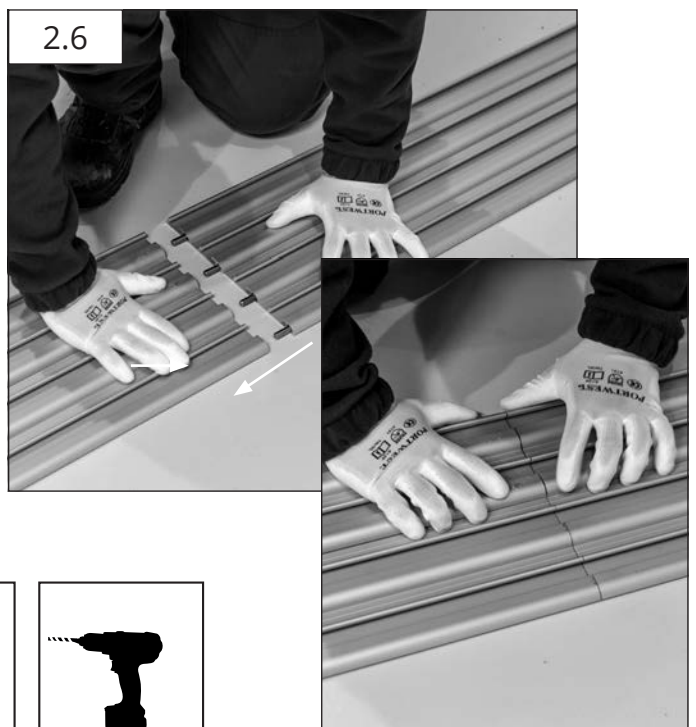
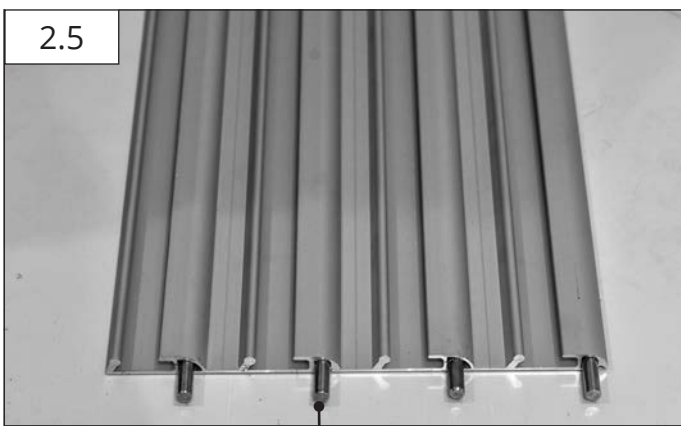
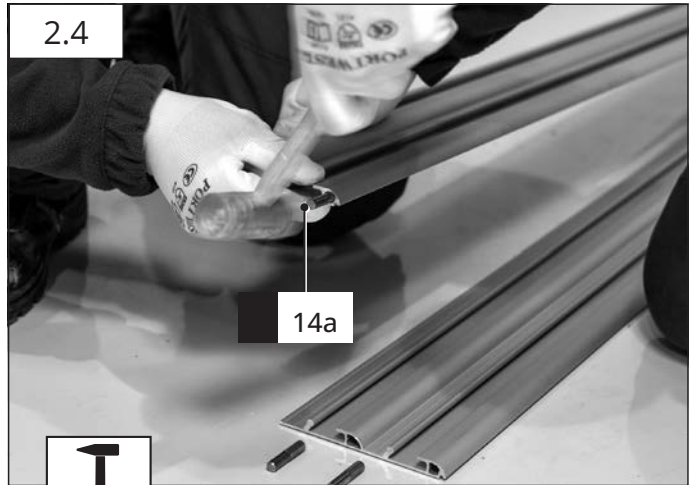
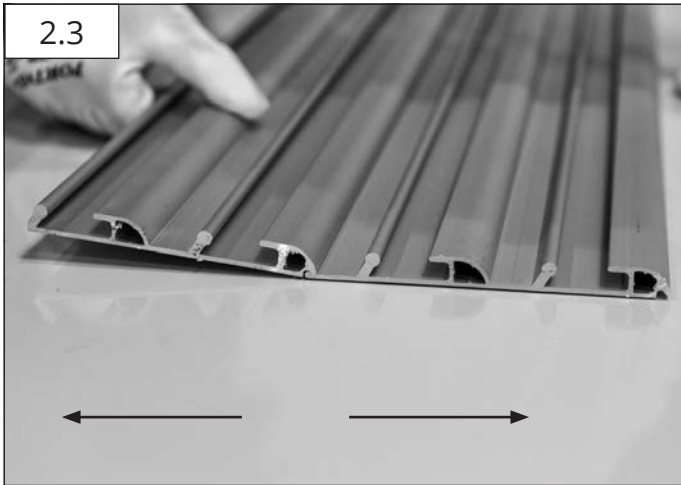

## 2 MONTERING SKENOR

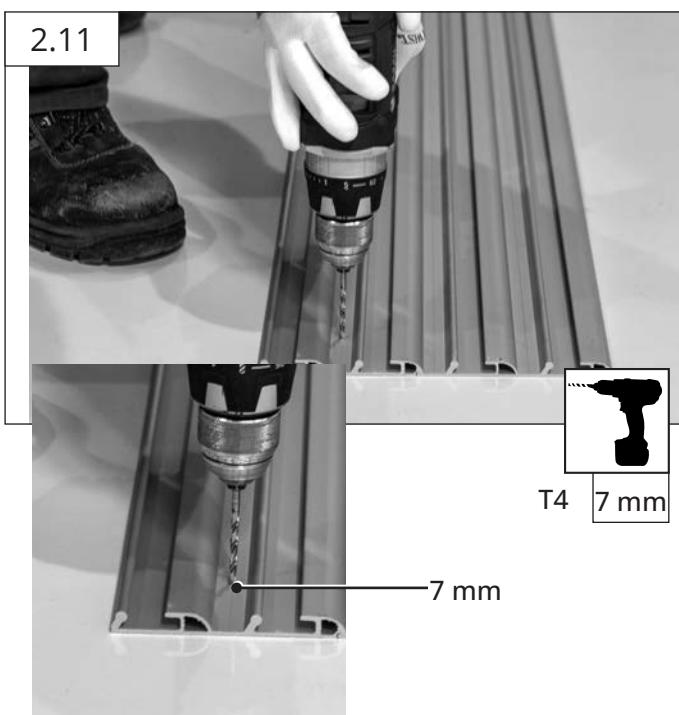
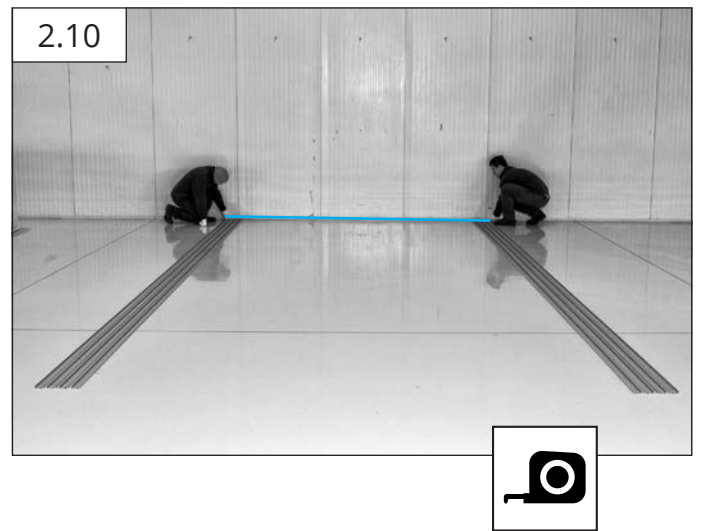
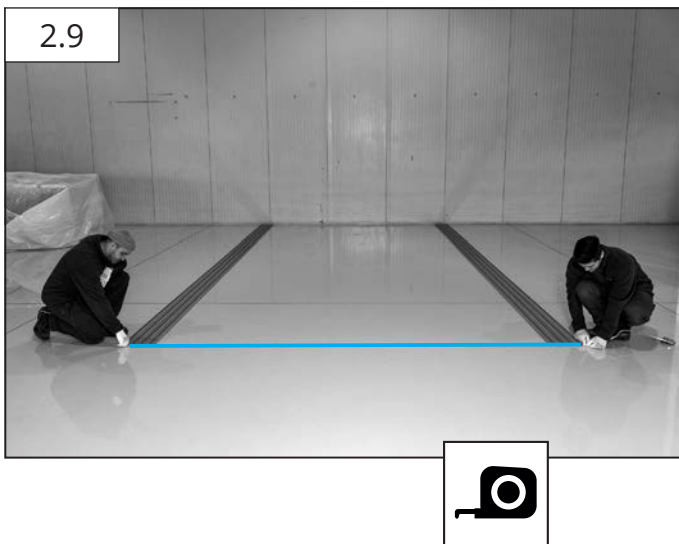
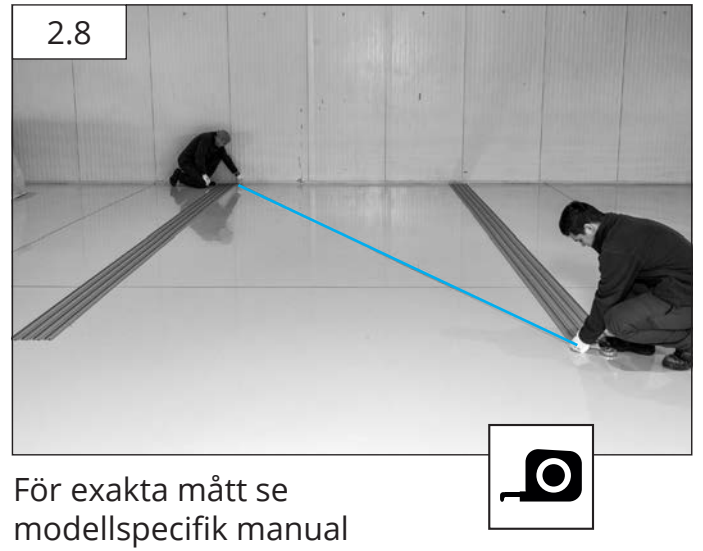
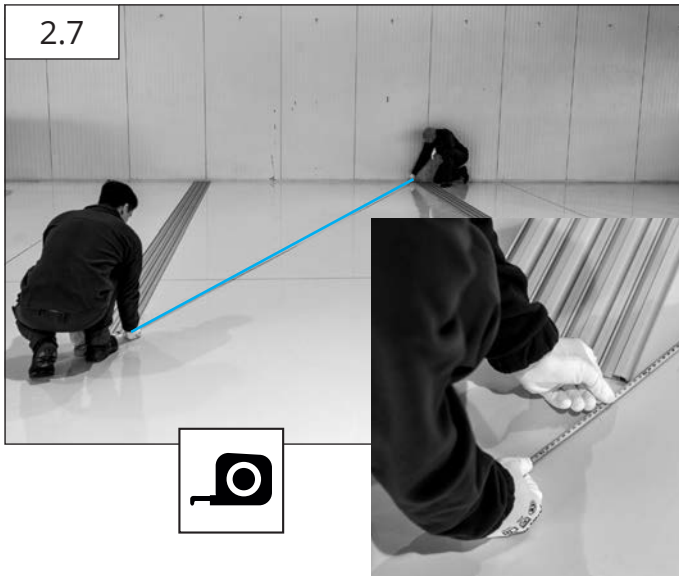

## 2 MONTERING SKENOR

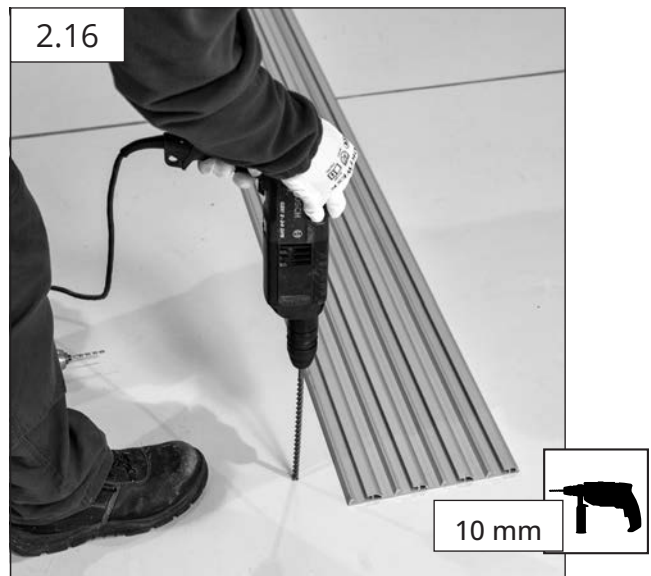
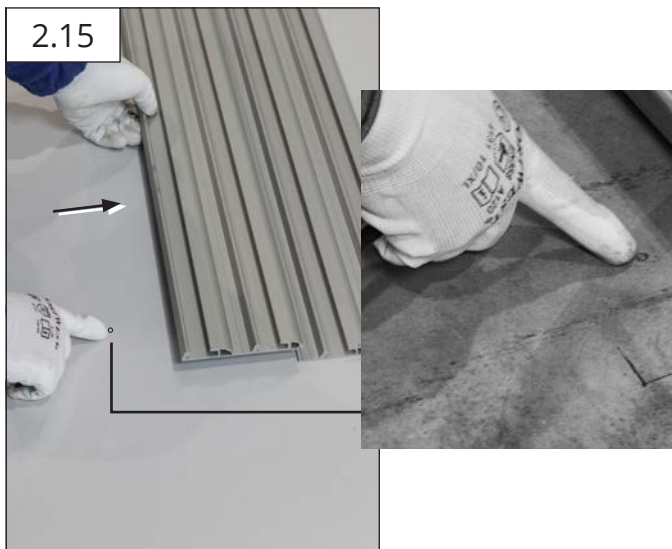
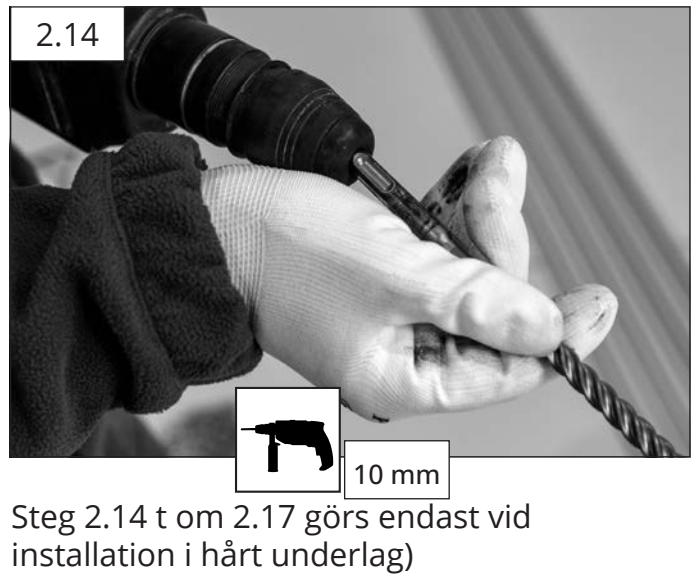

Förborrning i underlag samt plugg behövs ej vid installation i trätrall. Plugg medföljer ej boxtak.



## 2 MONTERING SKENOR

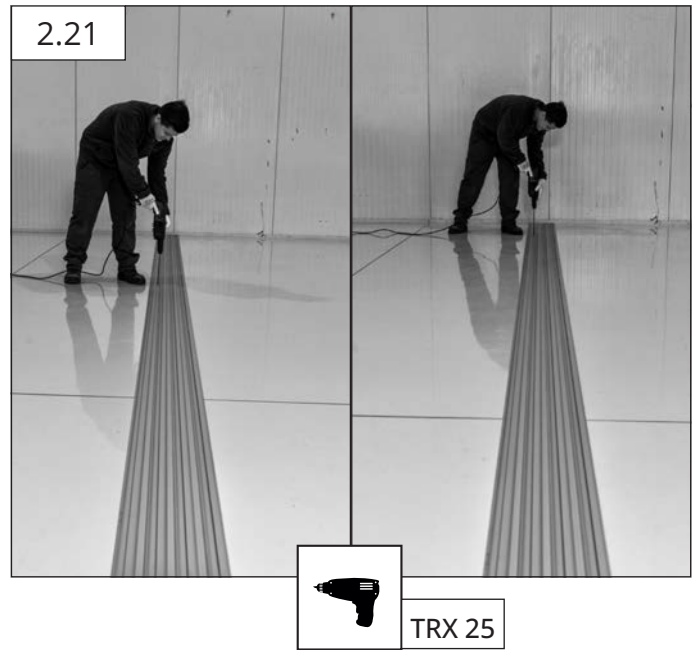
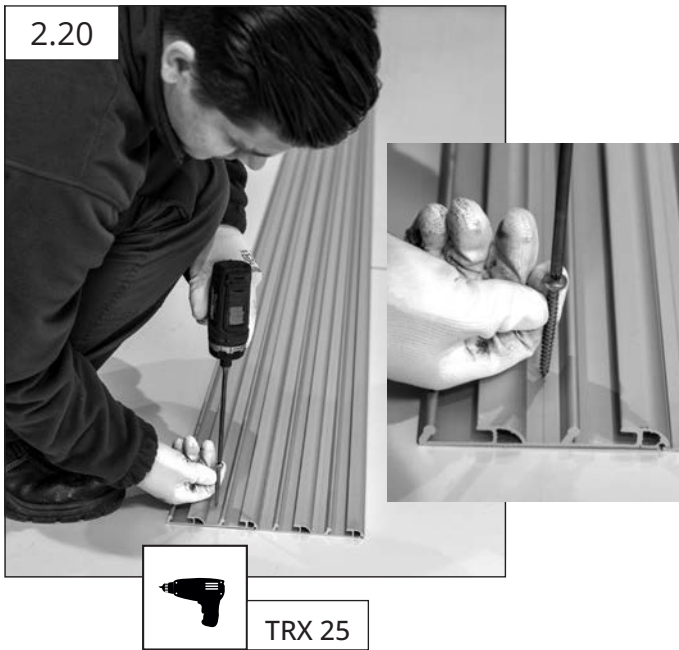
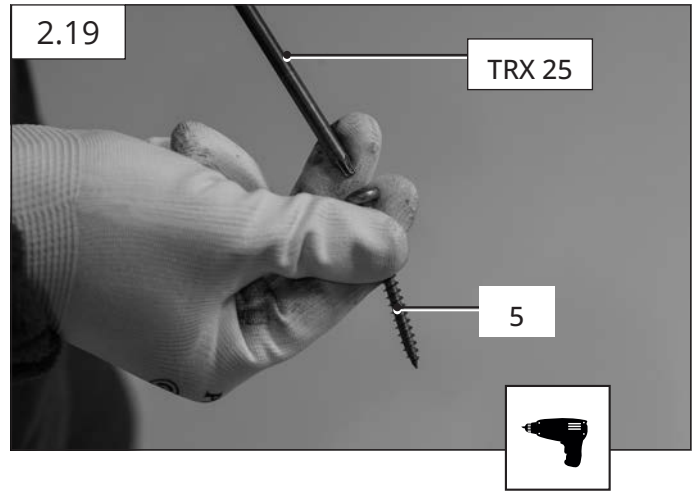

### 3 MONTERING STÖRSTA SEKTIONEN

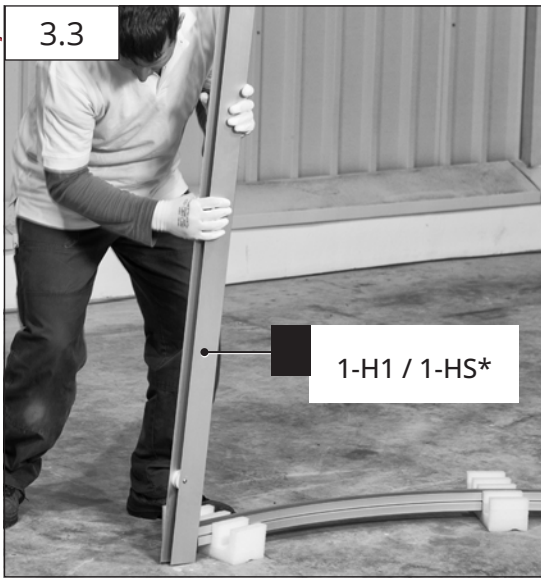
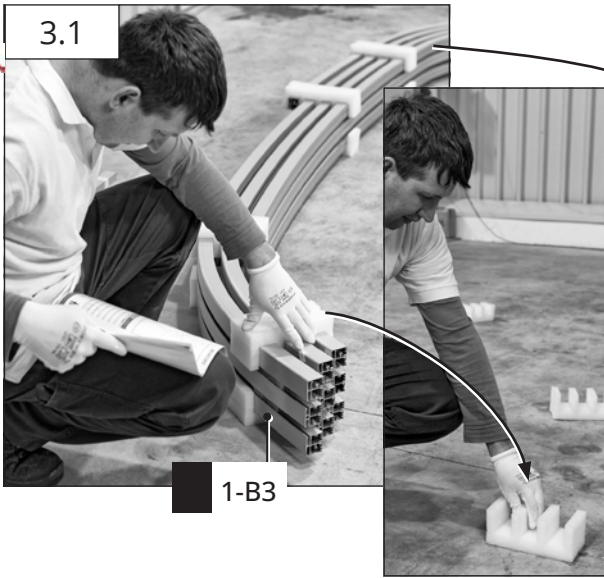

\*=1-HS där dörren placeras

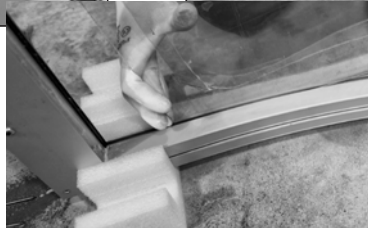
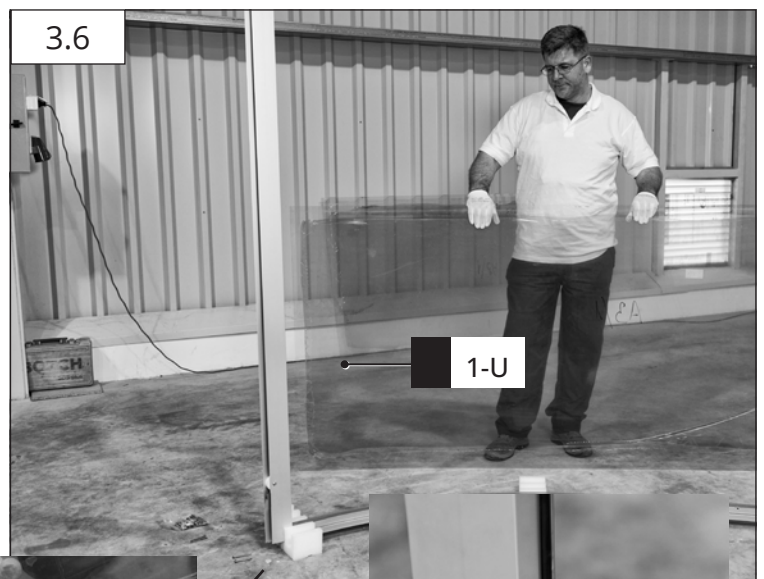
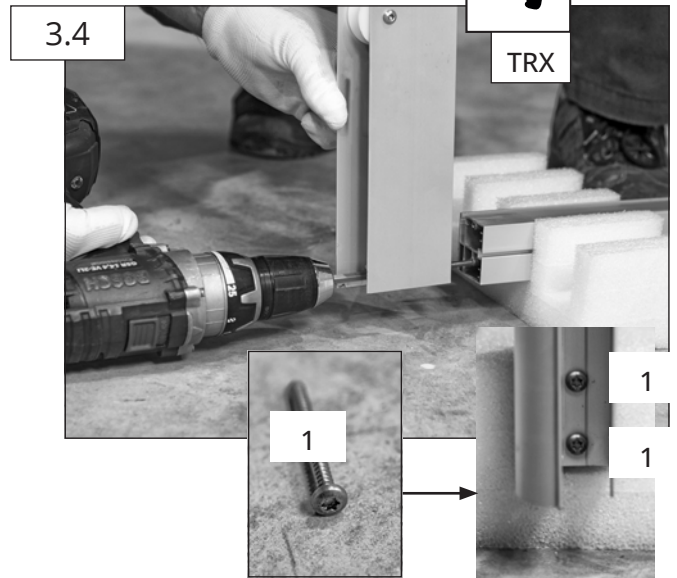

### 3 MONTERING STÖRSTA SEKTIONEN

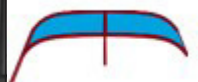
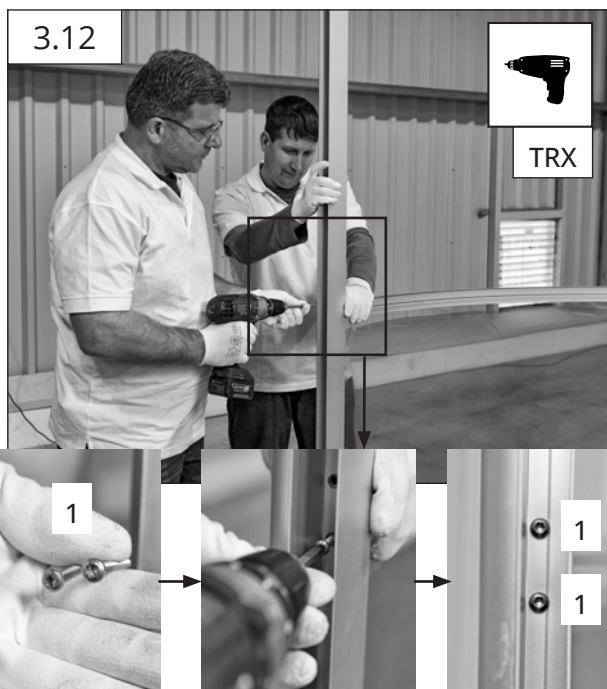
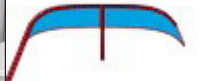
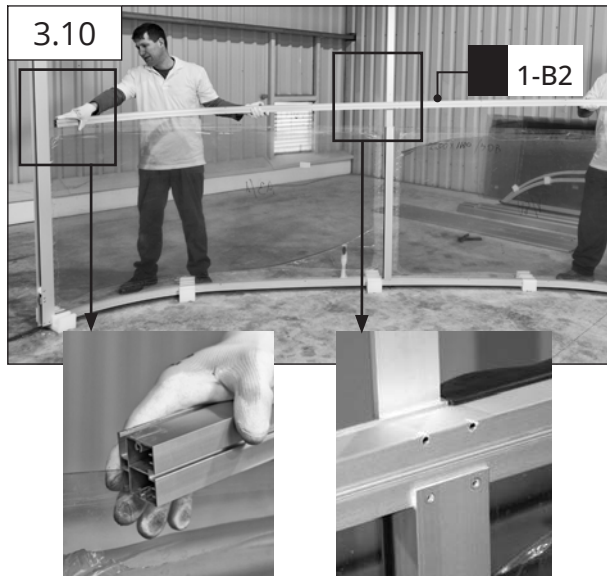
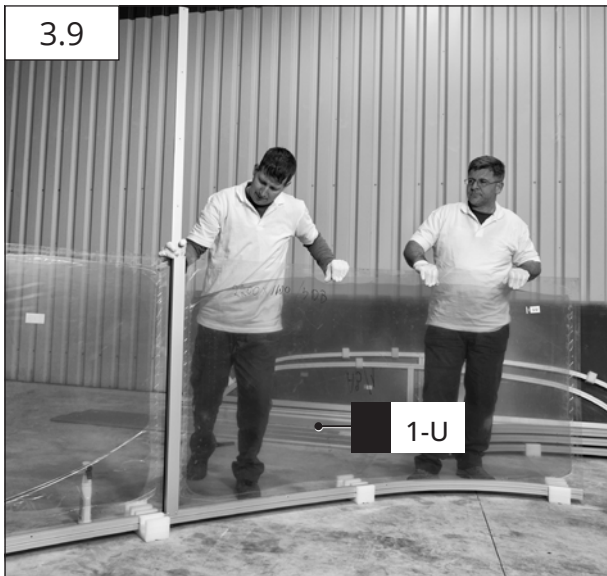
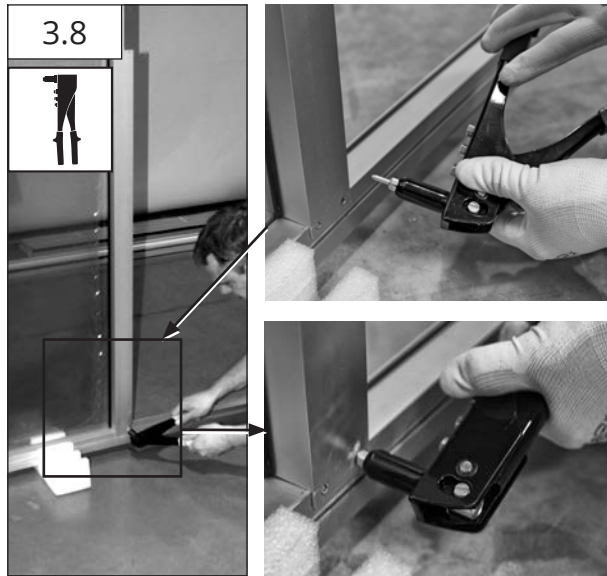

### 3 MONTERING STÖRSTA SEKTIONEN

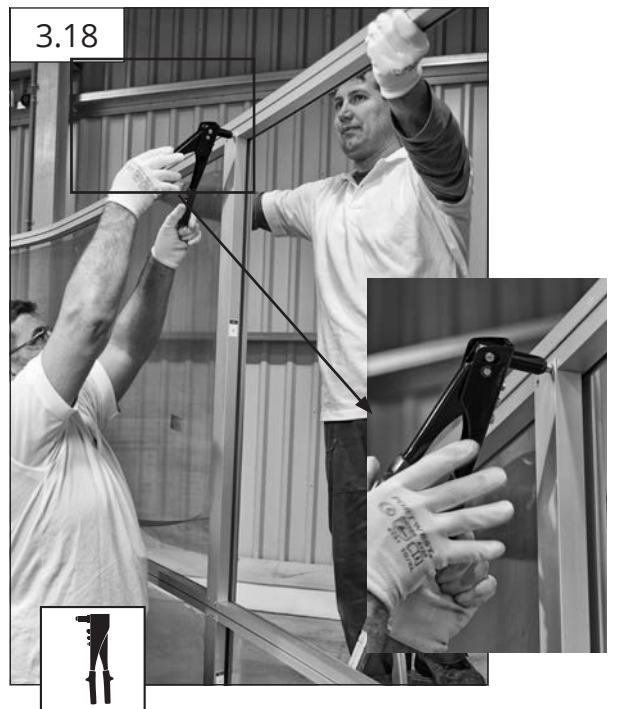
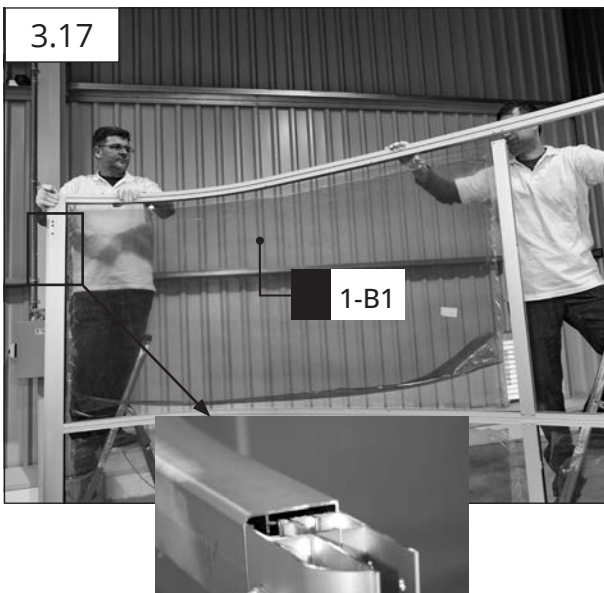
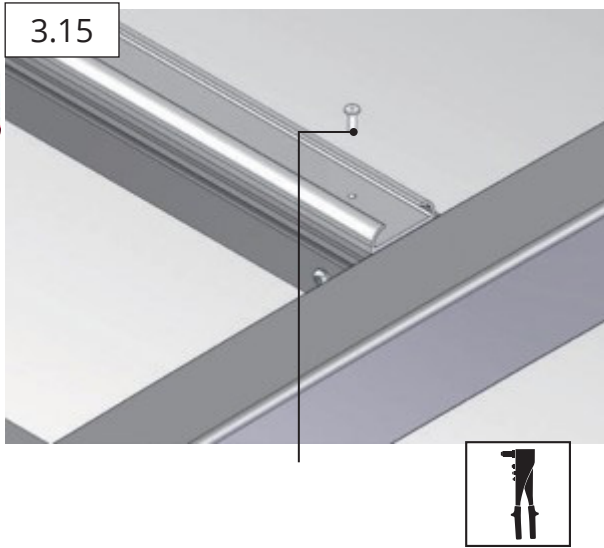
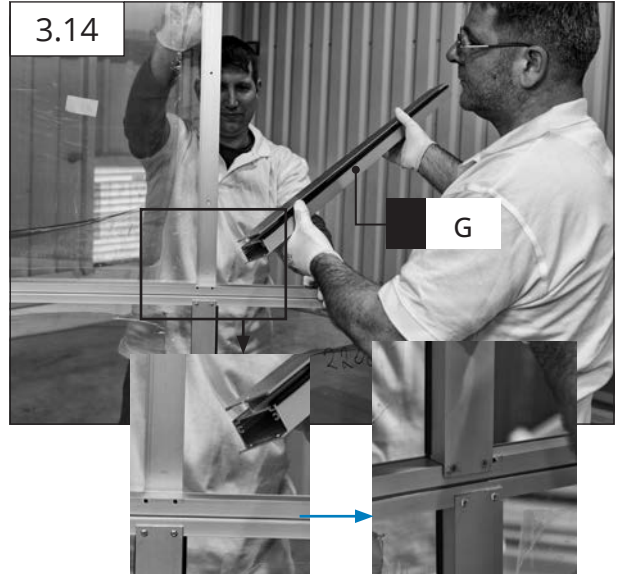
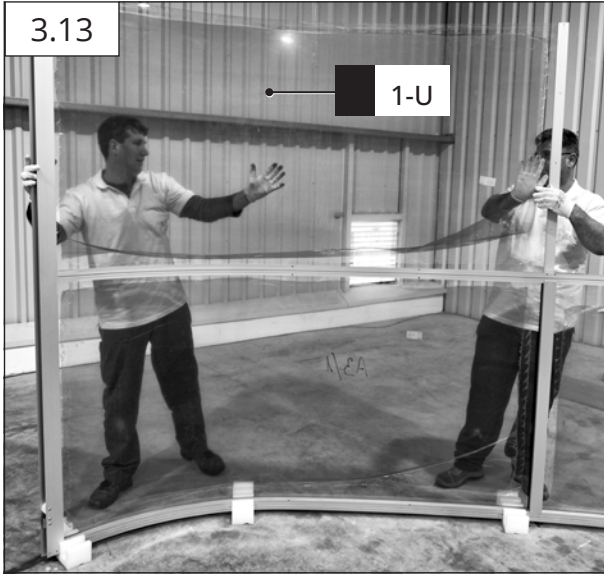

### 3 MONTERING STÖRSTA SEKTIONEN

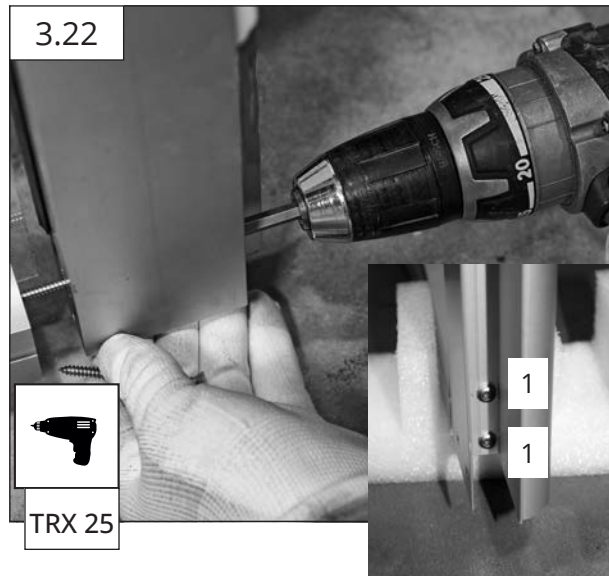
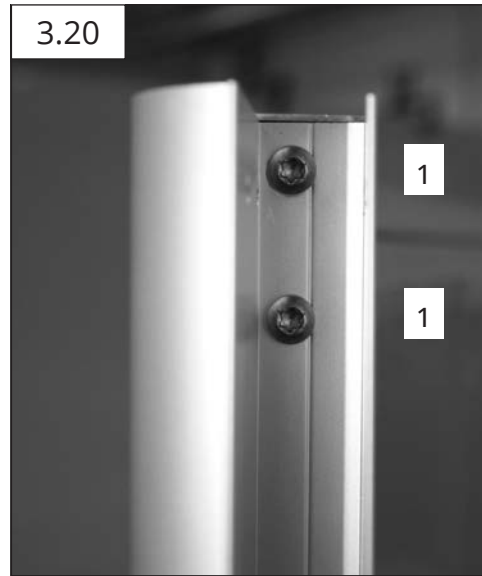
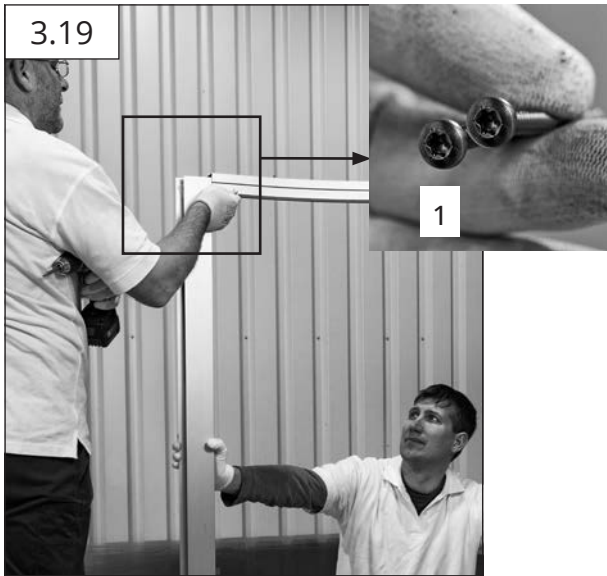

### 3 MONTERING STÖRSTA SEKTIONEN

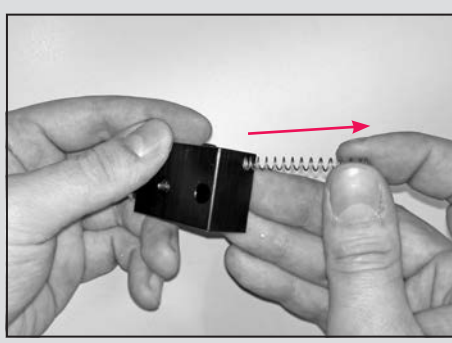
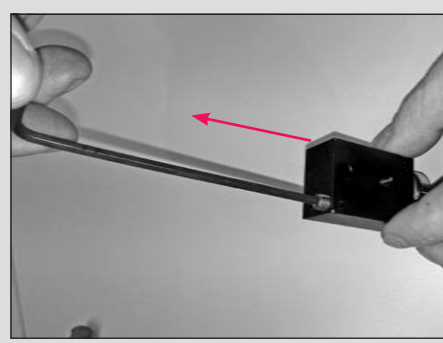
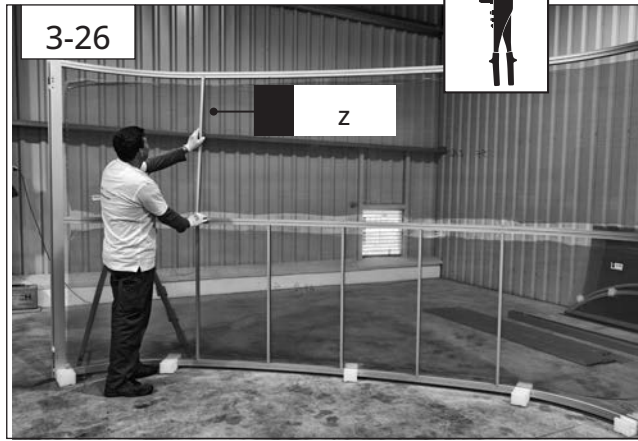

Valfritt: Genom att ta bort fjädern i den manuella låsningen så kommer låspinnen hamna i rätt läge på skenan vid stängning. Motsvarande sida måste då låsas manuellt när taket stängs.

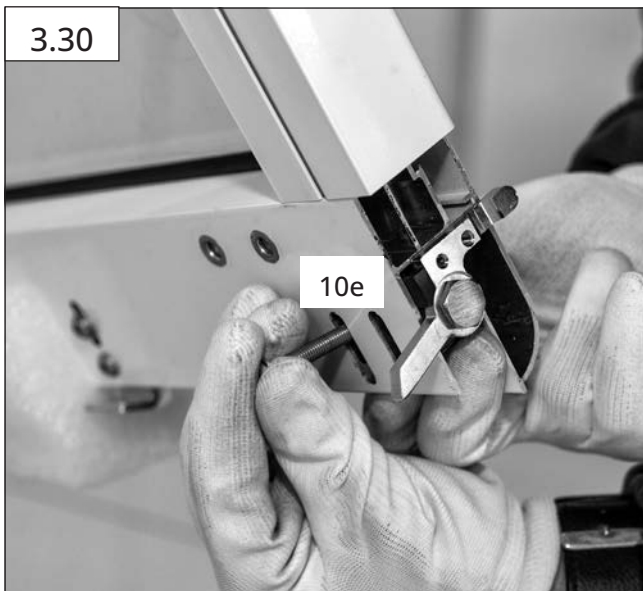
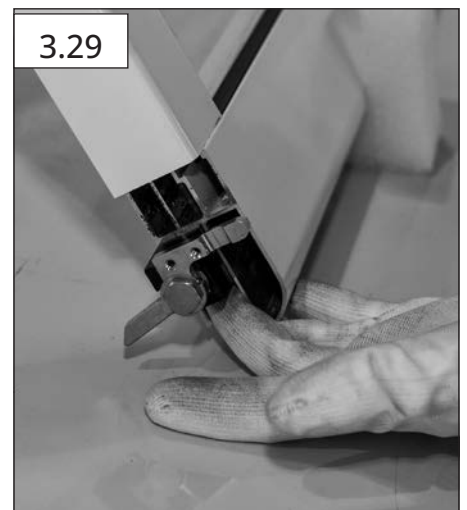
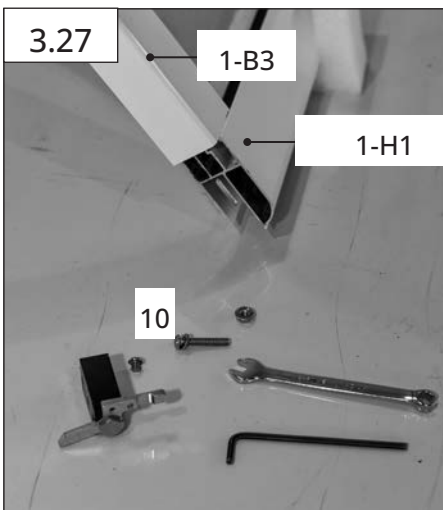

### 3 MONTERING STÖRSTA SEKTIONEN

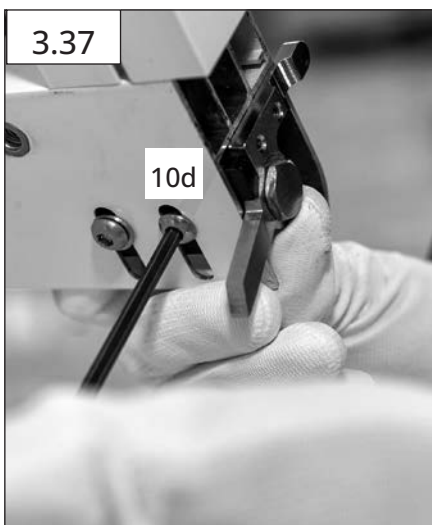
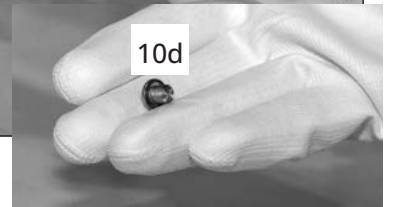
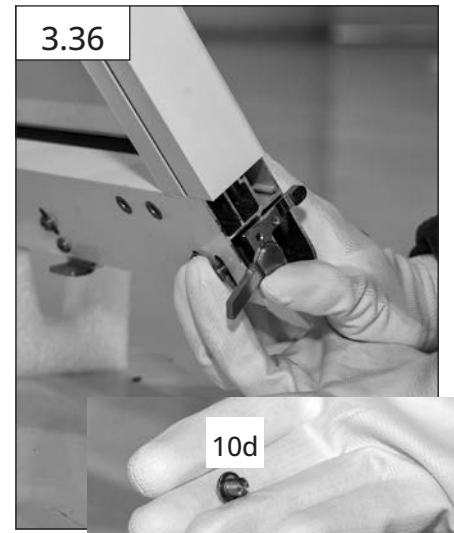

### 3 MONTERING STÖRSTA SEKTIONEN

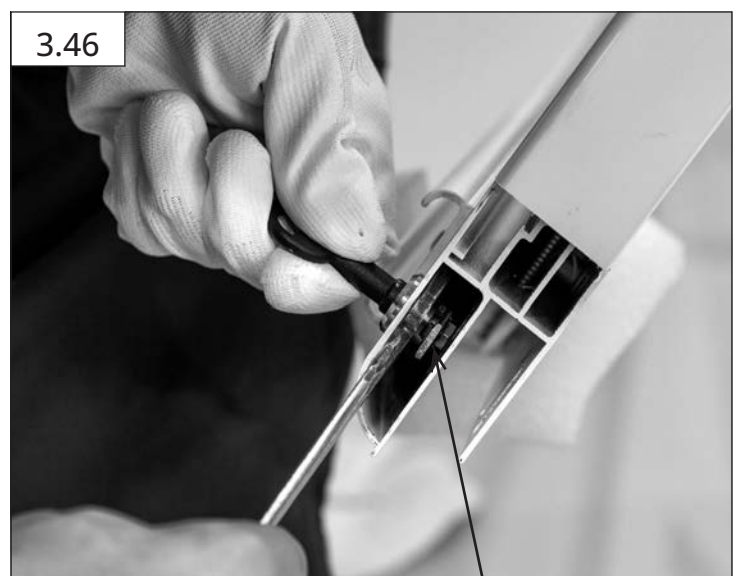
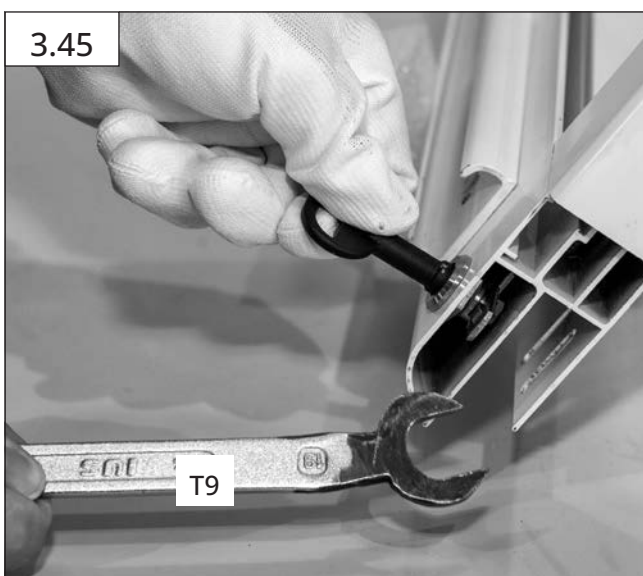
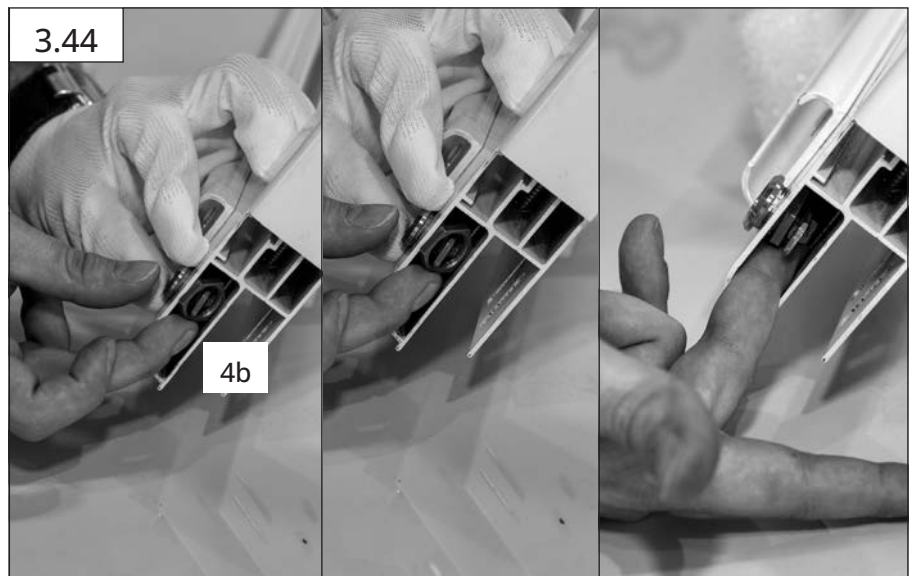
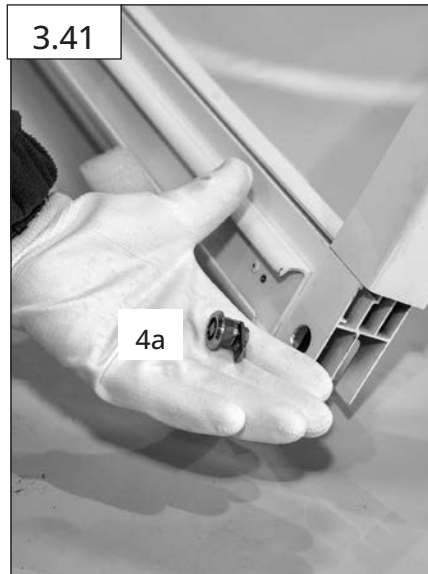
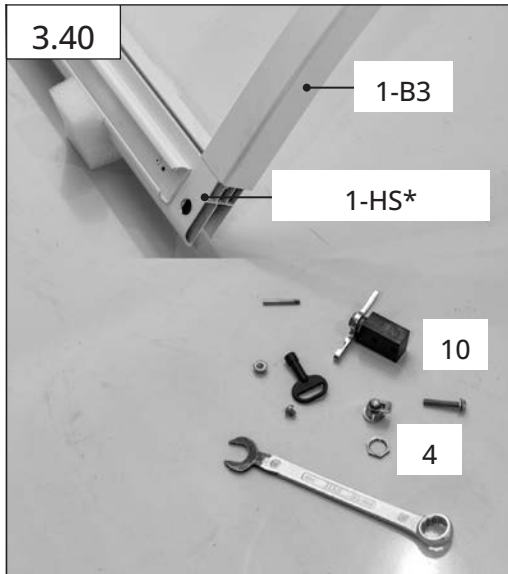

1-HS\*= Dörrens placering

OBS! Låstungans position!

### 3 MONTERING STÖRSTA SEKTIONEN

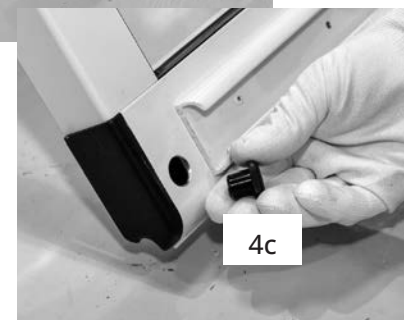
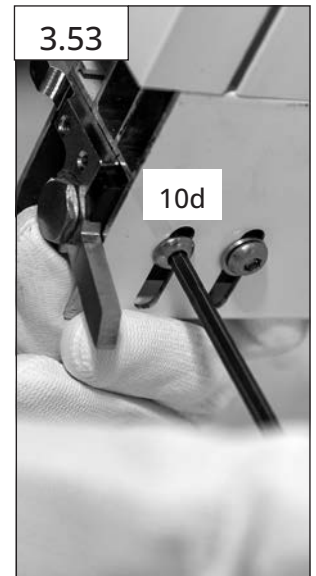
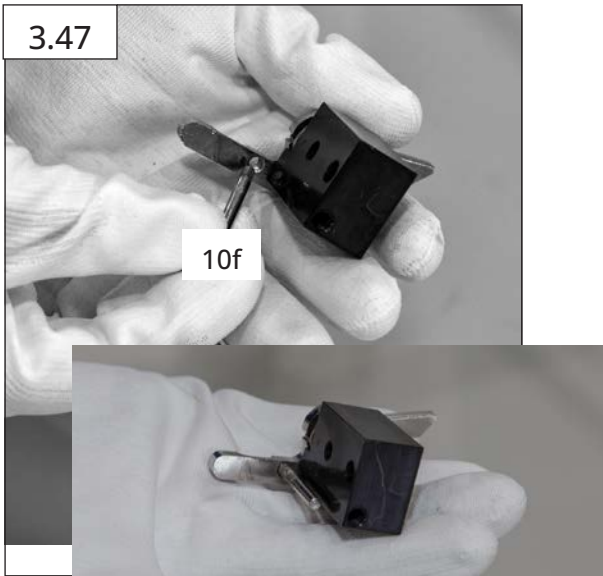

## 4 MONTERING ÖVRIGA SEKTIONER

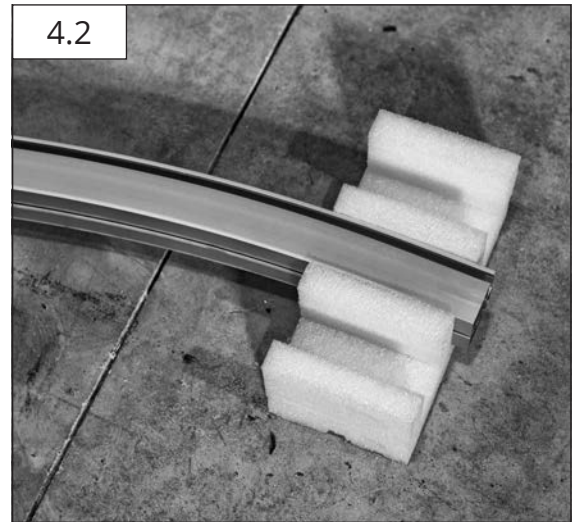
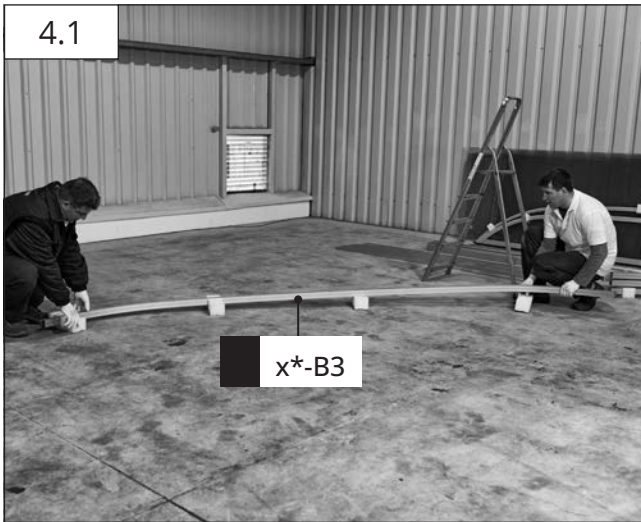

X\*= Nummer på sektion, ex 2-B3 är andra sektionen och 3:e bågpprofilen (sett framifrån största sektionen)

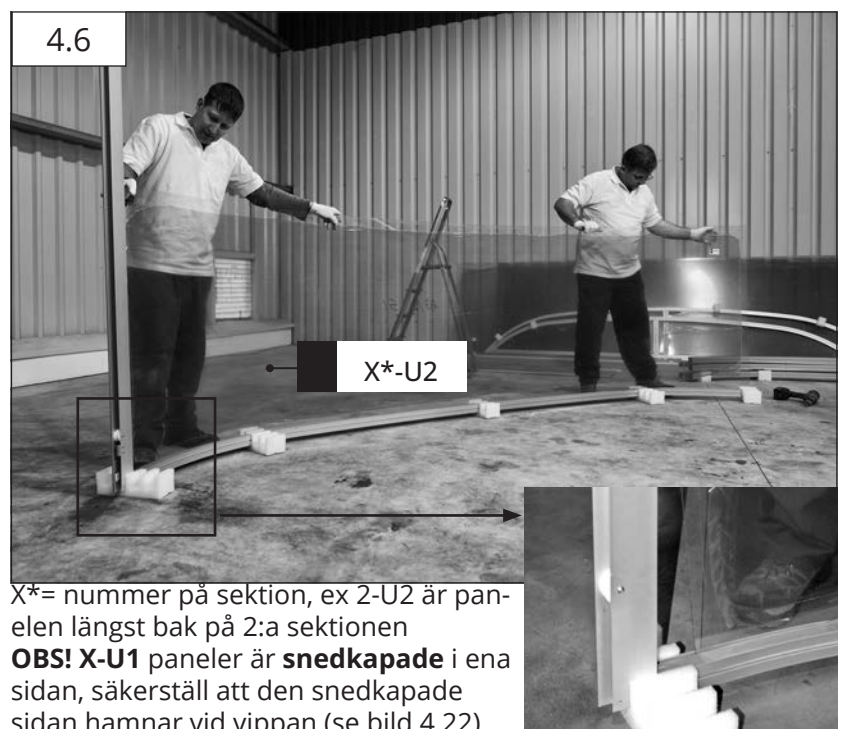
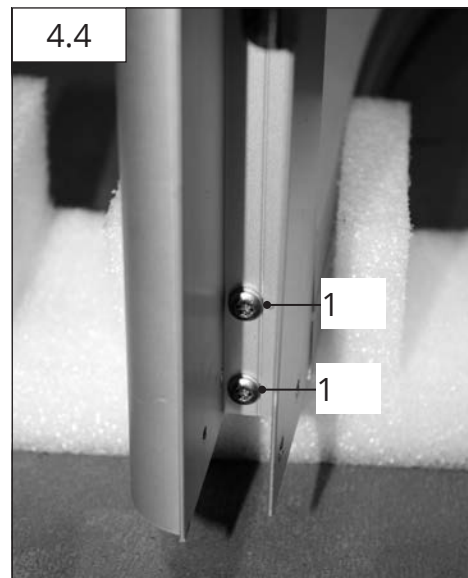
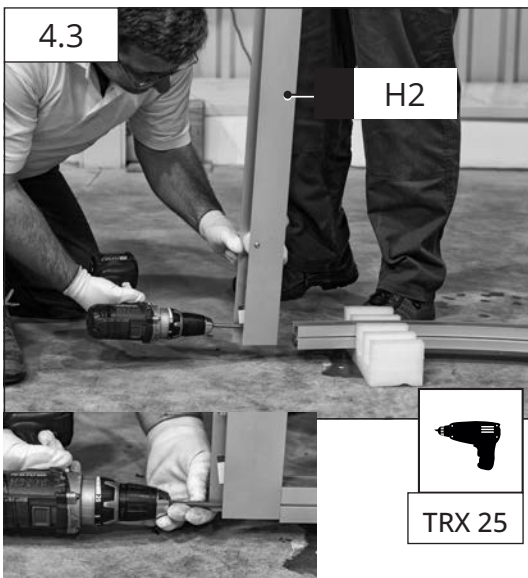

# 4 MONTERING ÖVRIGA SEKTIONER

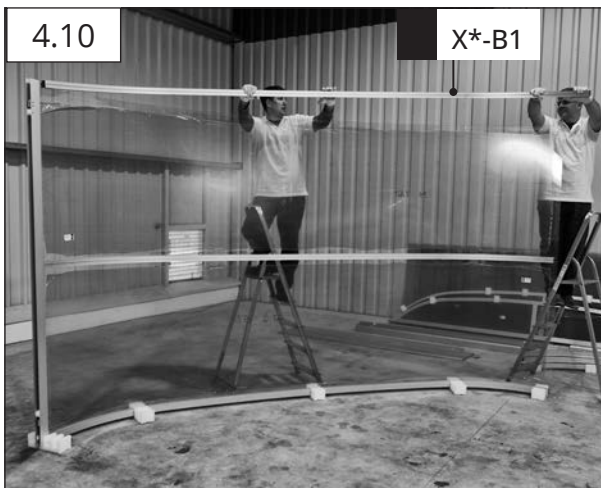
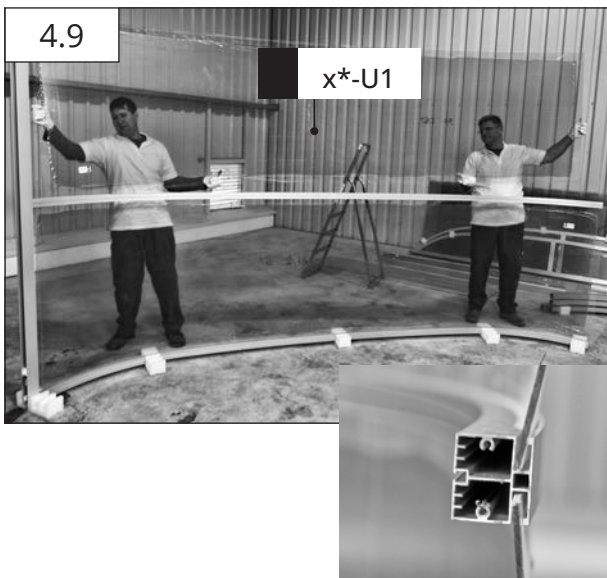
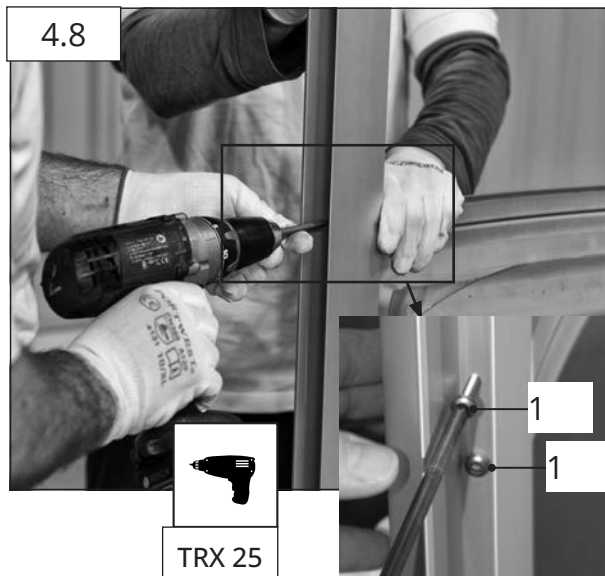
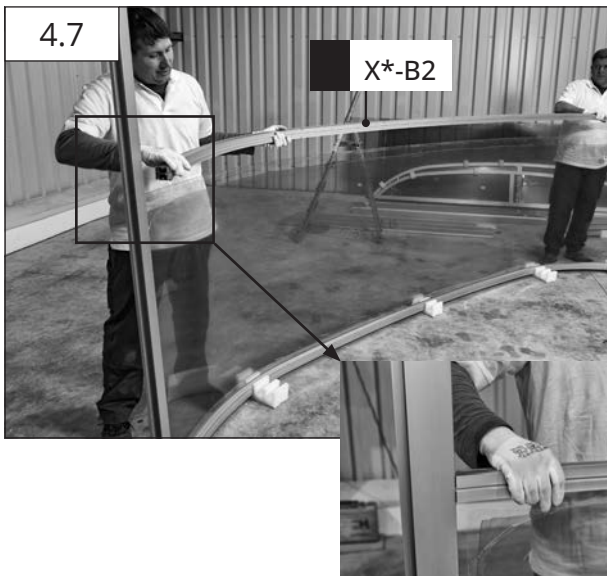

**OBS! Snedkapade X-U1 paneler ska sitta vid vippan längst fram på varje sektion förutom största sektionen**

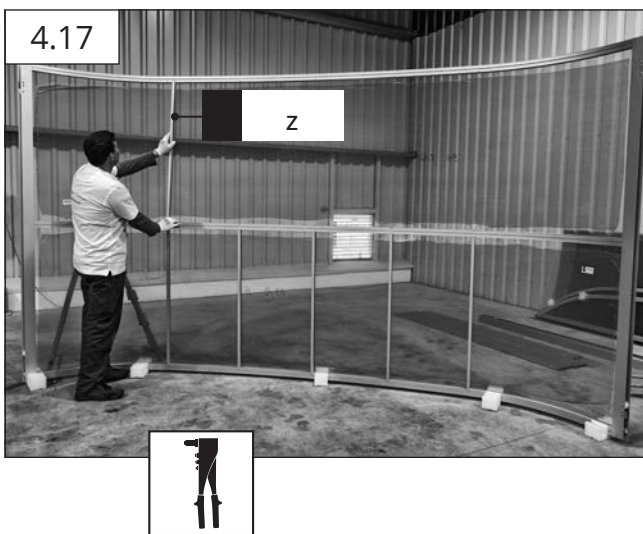
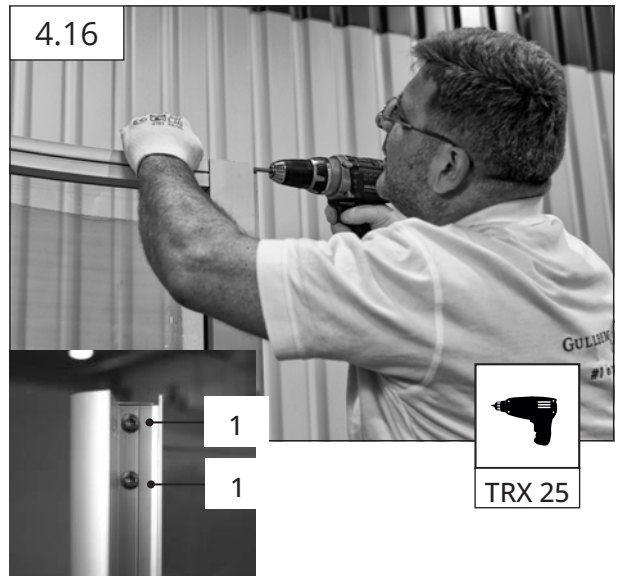
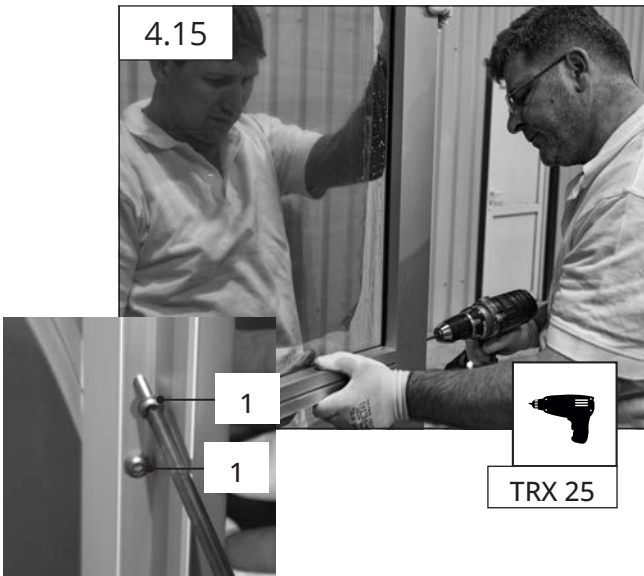
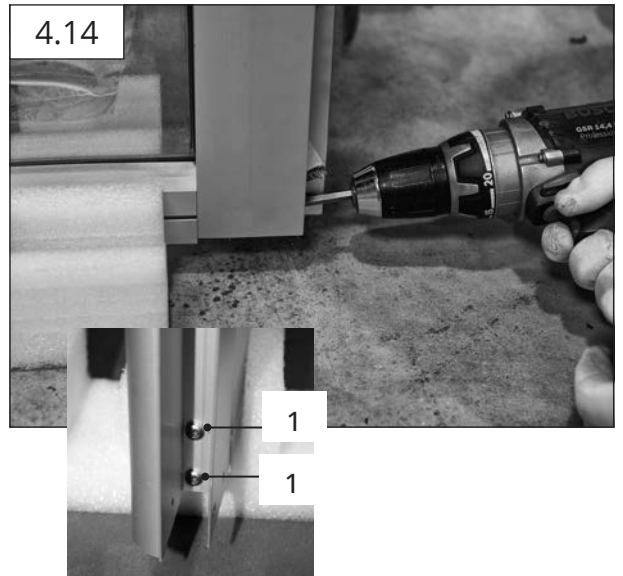

4.19

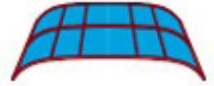

# 4 MONTERING ÖVRIGA SEKTIONER

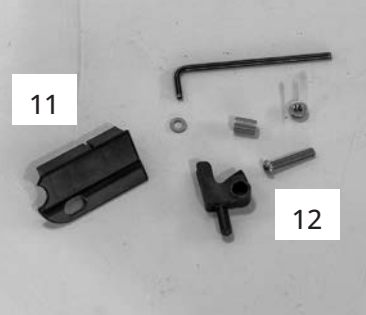

OBS! Vippan skall installeras så den bär upp hylsan!

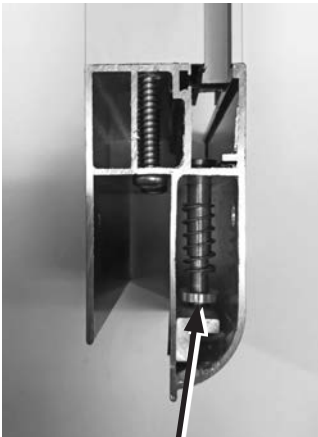

FEL

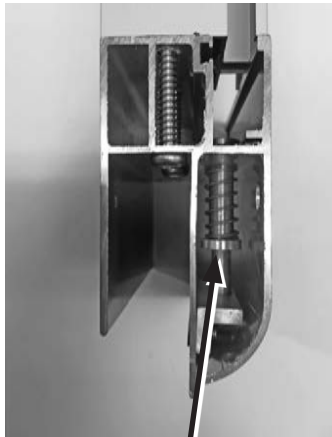

Rätt

Säkerställ att bricken är i rätt position!



4.23

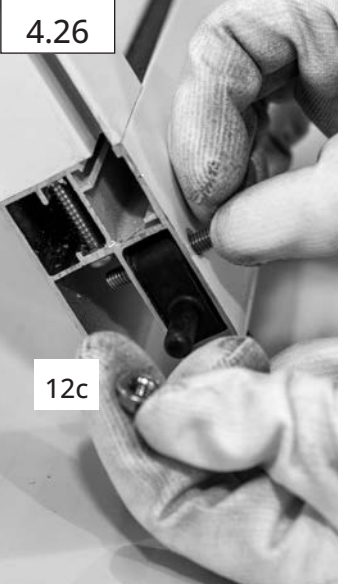
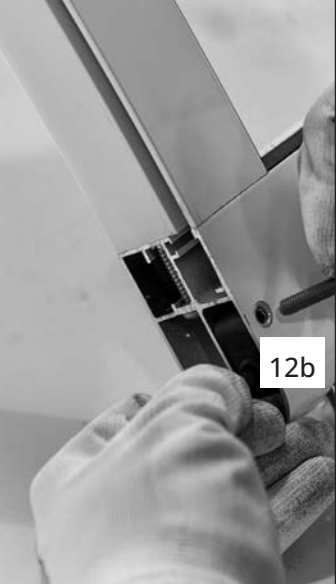
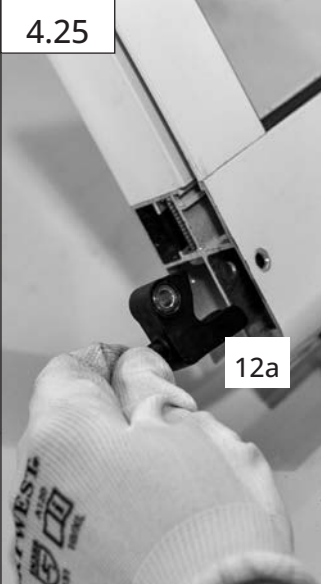

# 4 MONTERING ÖVRIGA SEKTIONER

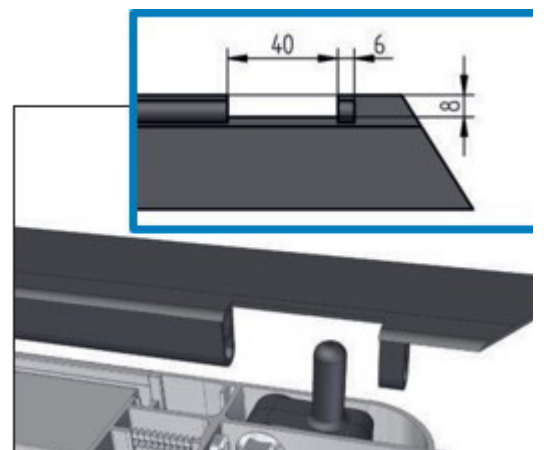
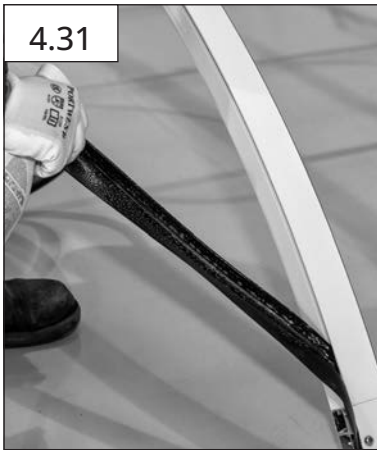

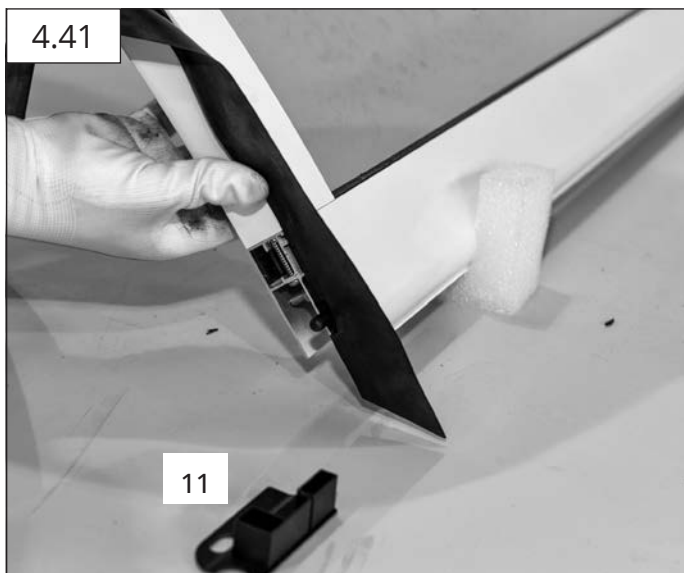

UPPREPA STEG  
4.1 - 4.47  
FÖR  
RESTERANDE  
SEKTIONER  
(SE SIDORNA 20-26)

# 5 MONTERING GUMMILISTER

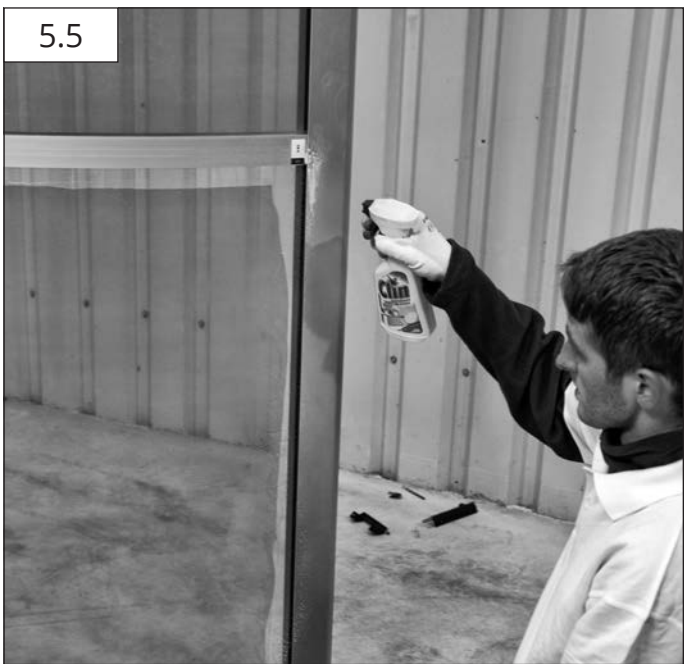
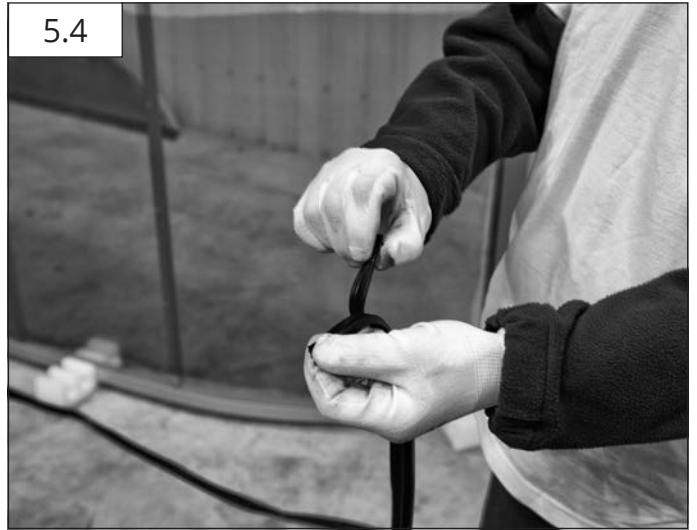
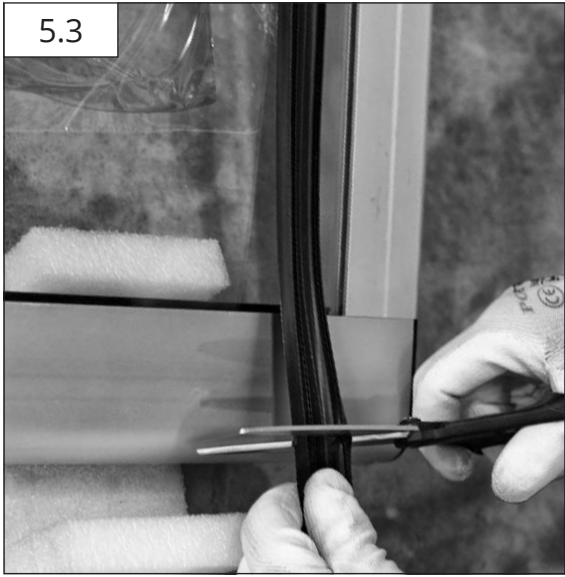

# 5 MONTERING GUMMILISTER



# 5 MONTERING GUMMILISTER

5.13



5.14



5.15



5.16

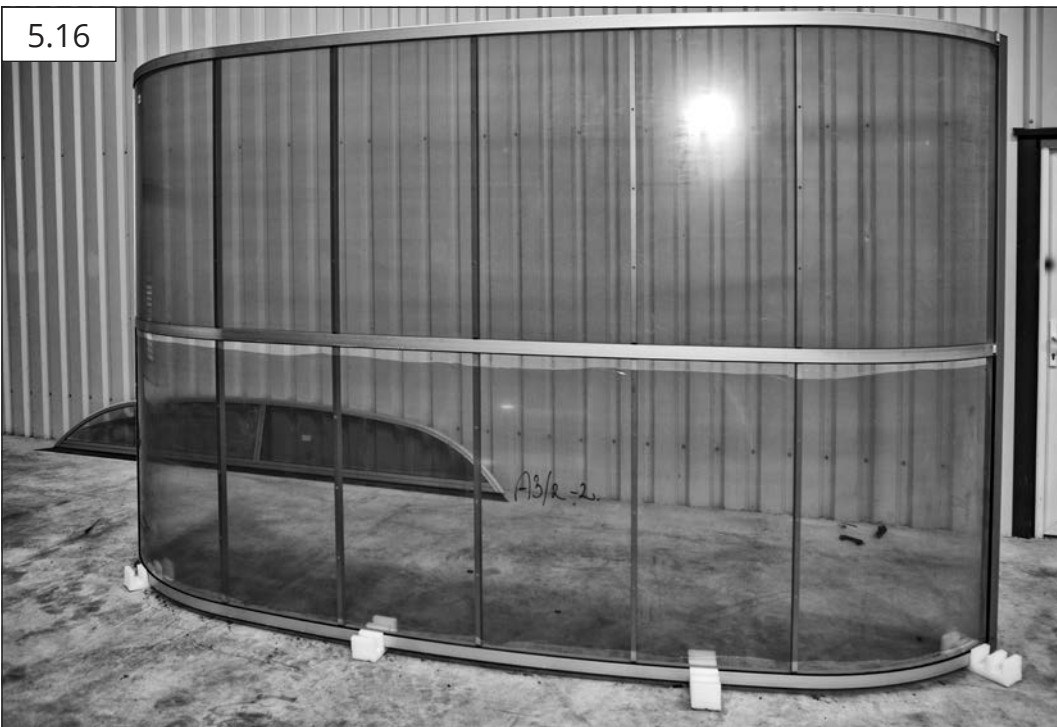

# 6 MONTERING SKJUTDÖRR

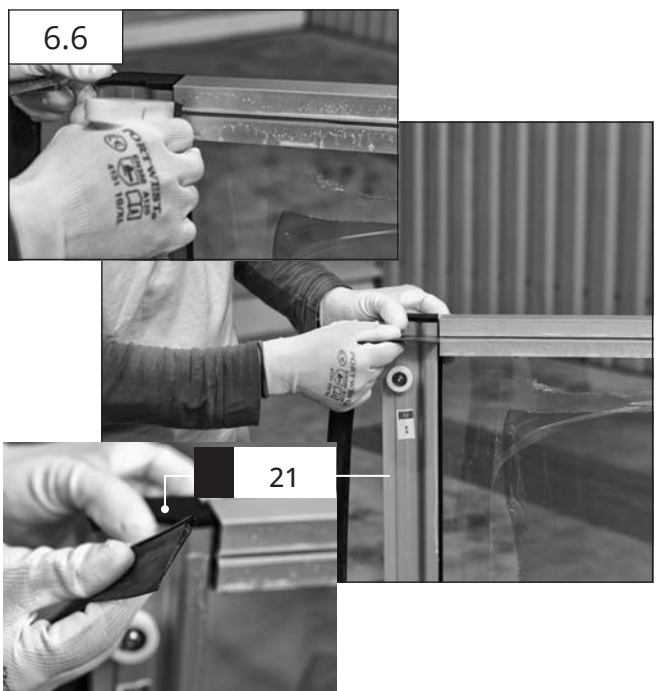
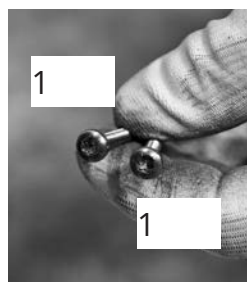
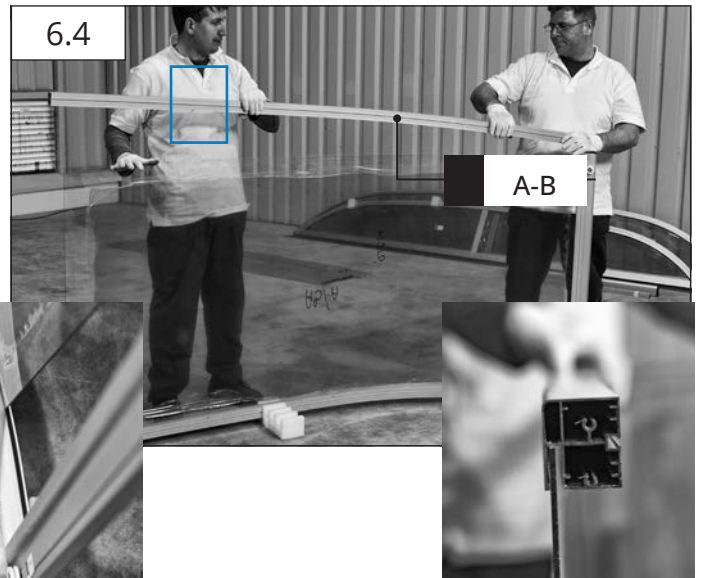
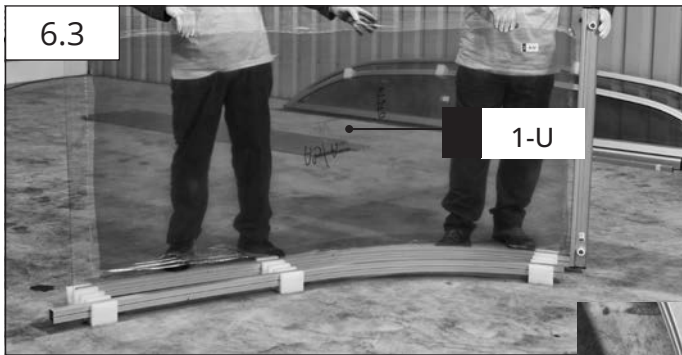
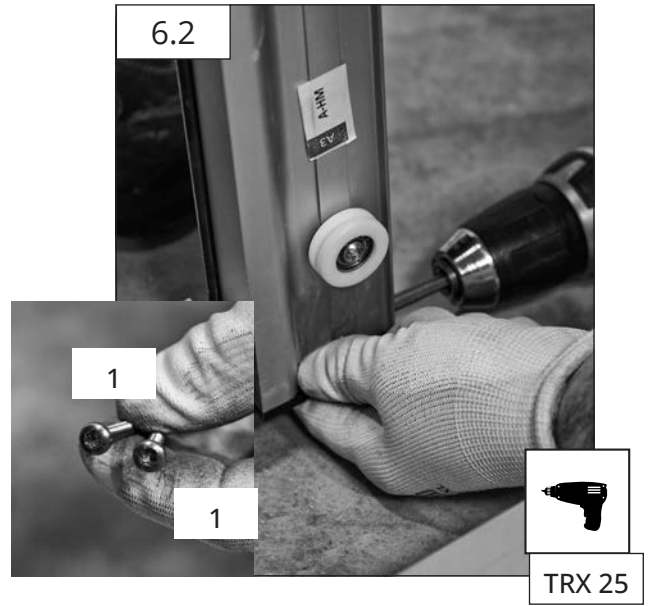
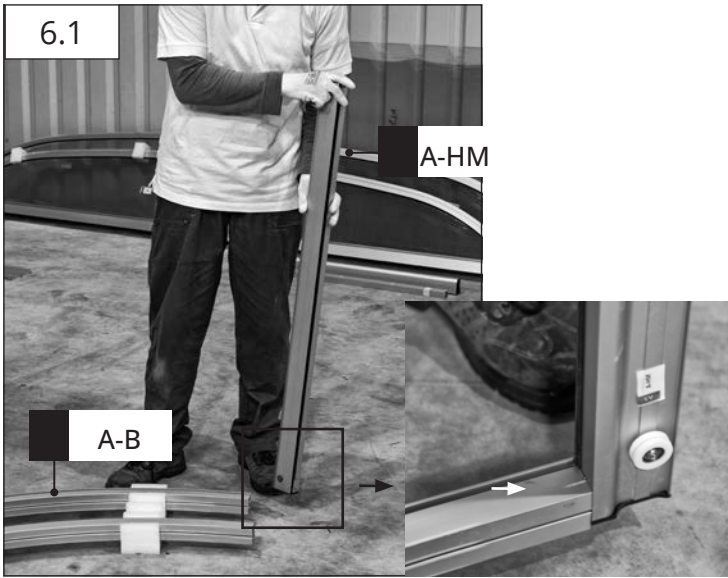

# 6 MONTERING SKJUTDÖRR

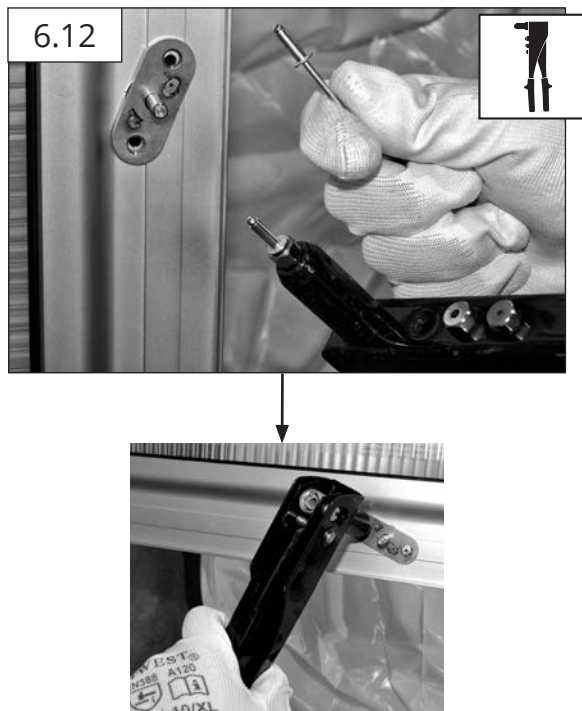
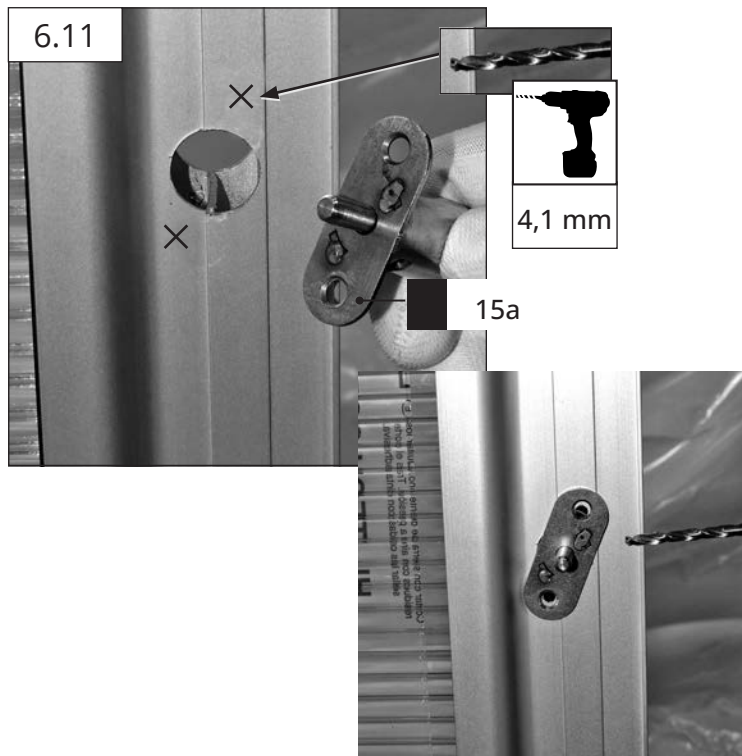
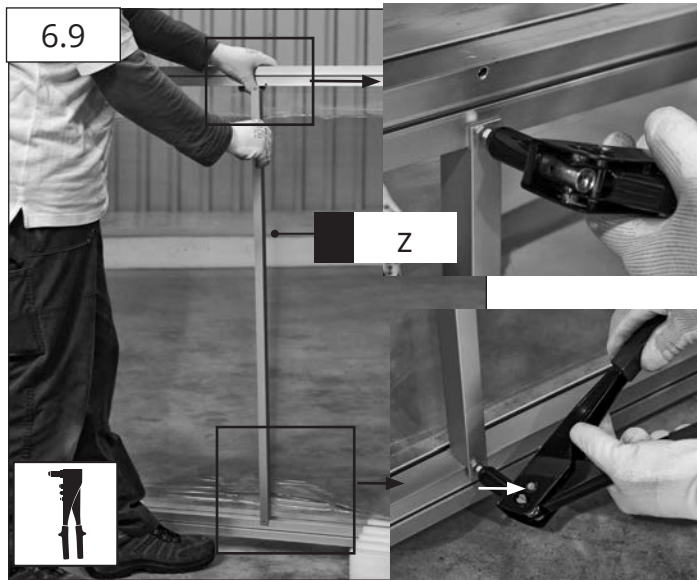
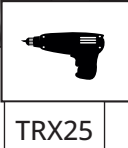

## 6 MONTERING SKJUTDÖRR

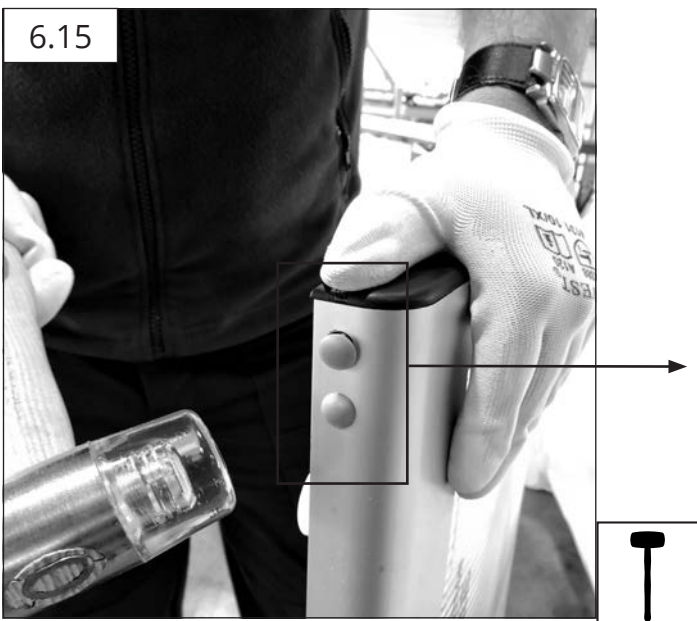

# 6 MONTERING SKJUTDÖRR

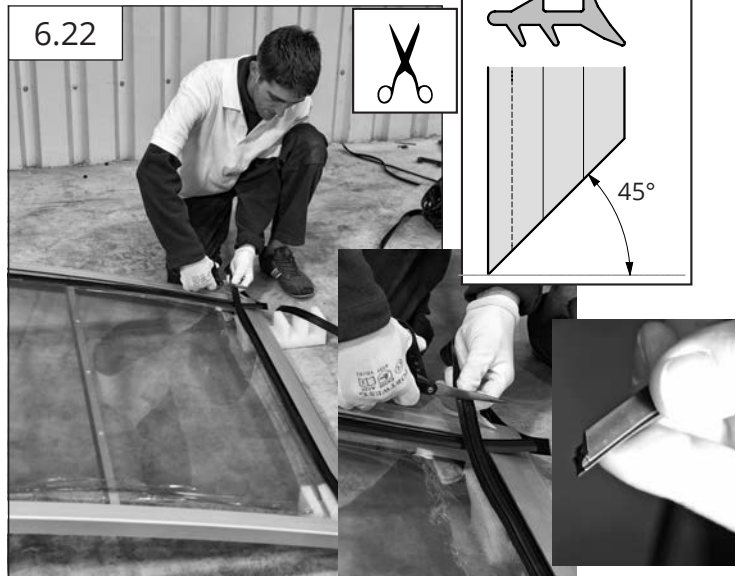
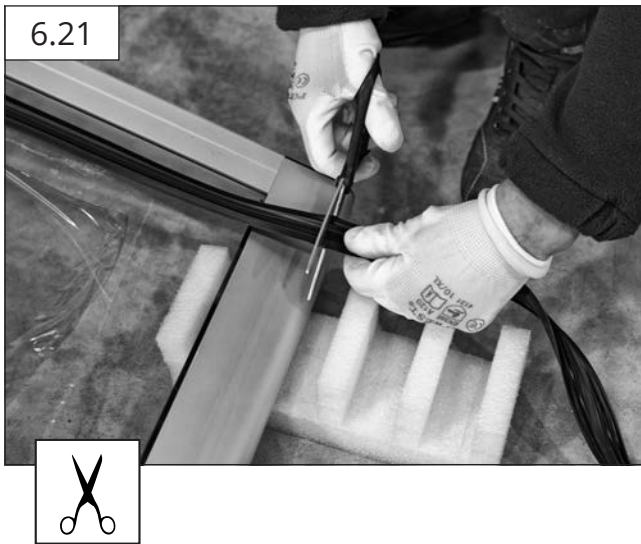
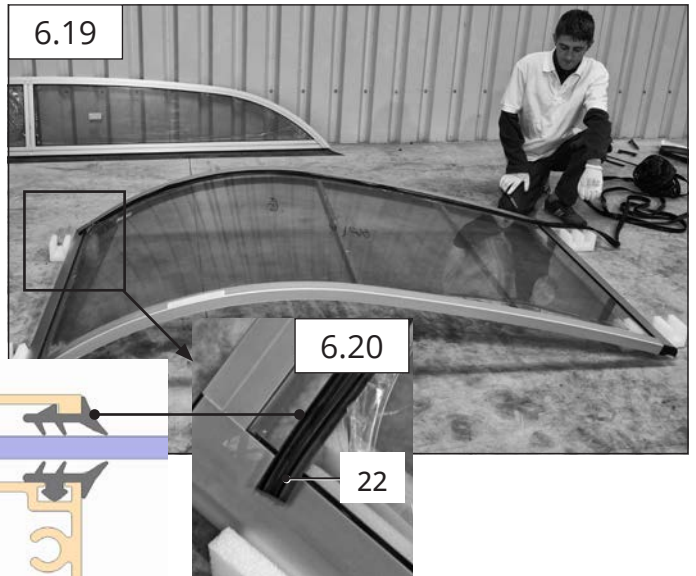
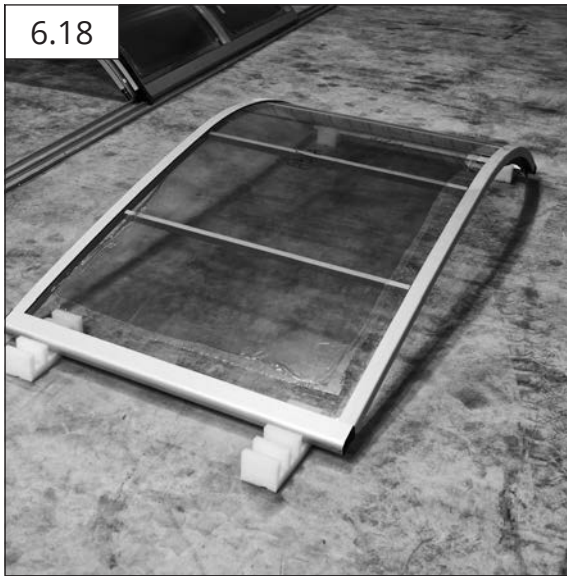

## 6 MONTERING SKJUTDÖRR

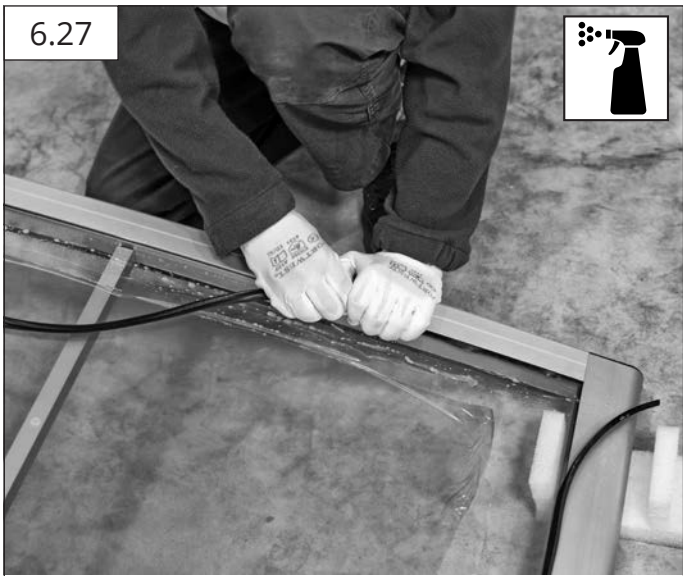
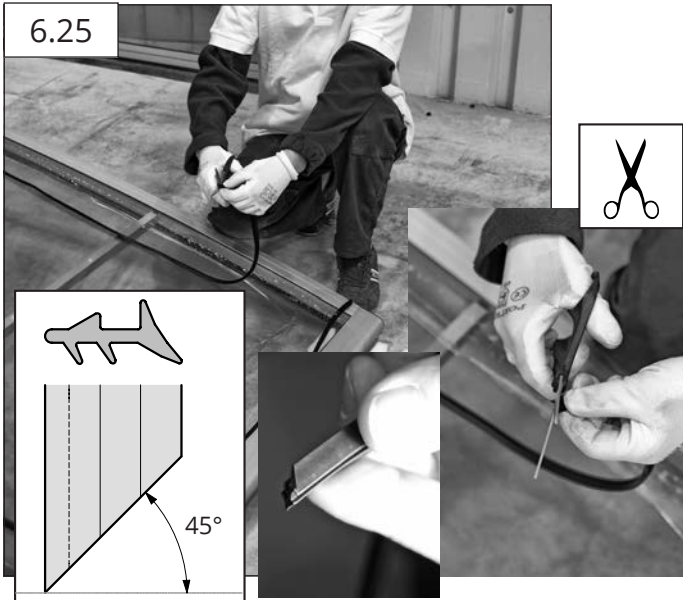

## 6 MONTERING SKJUTDÖRR

6.31



6.32



6.33



## 7 MONTERING AV SEKTIONERNA PÅ SKENA

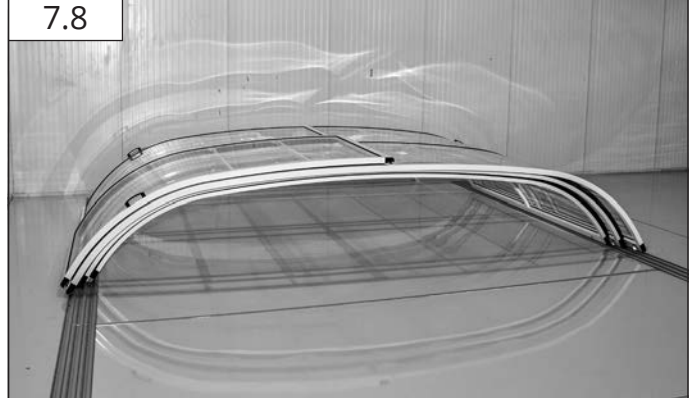
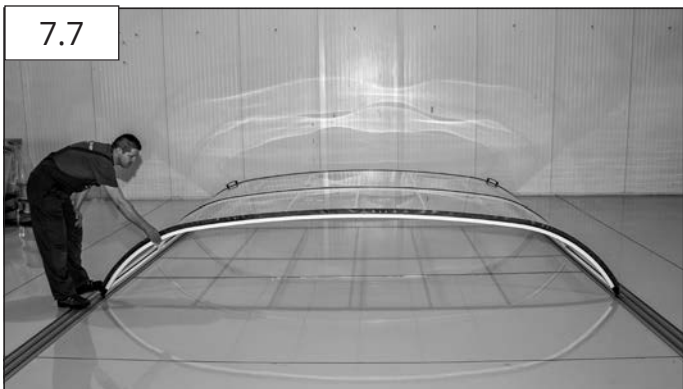
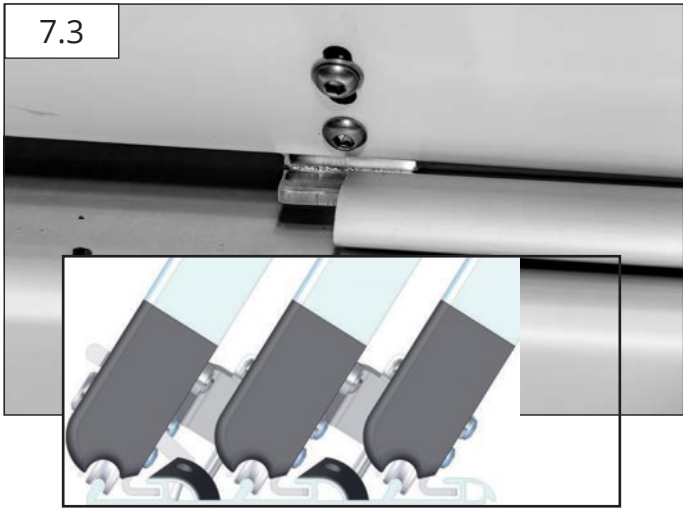
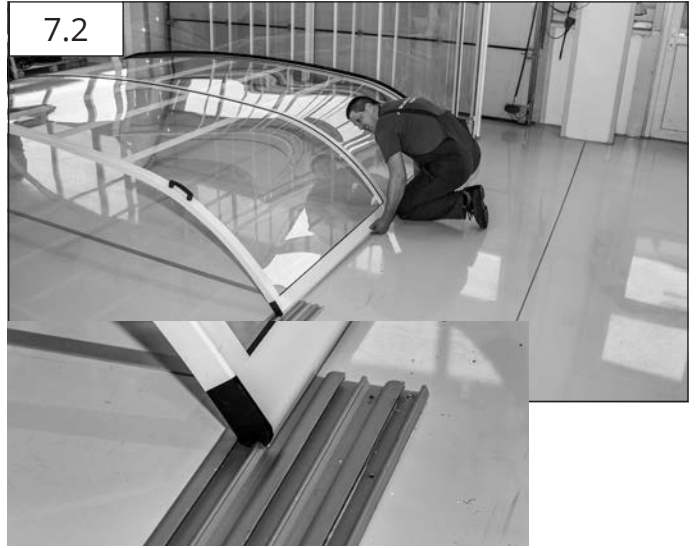

# 8 MONTERING AV GAVLAR

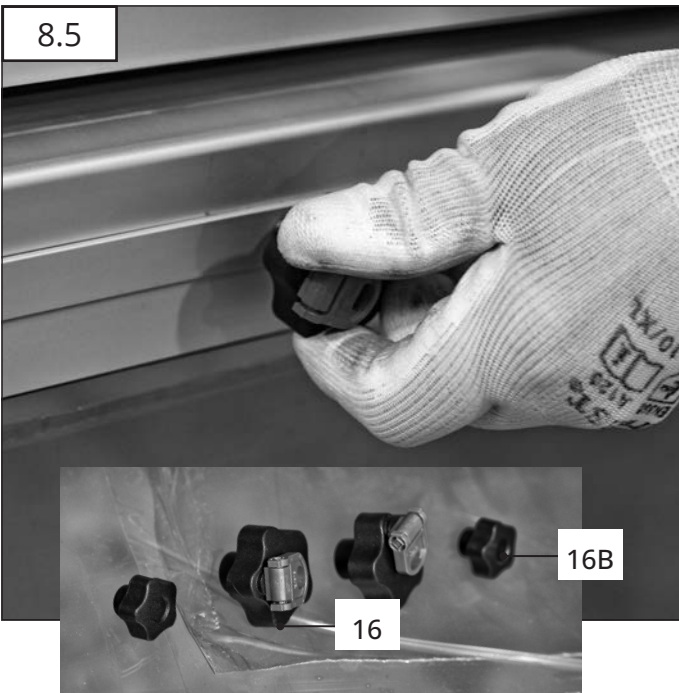
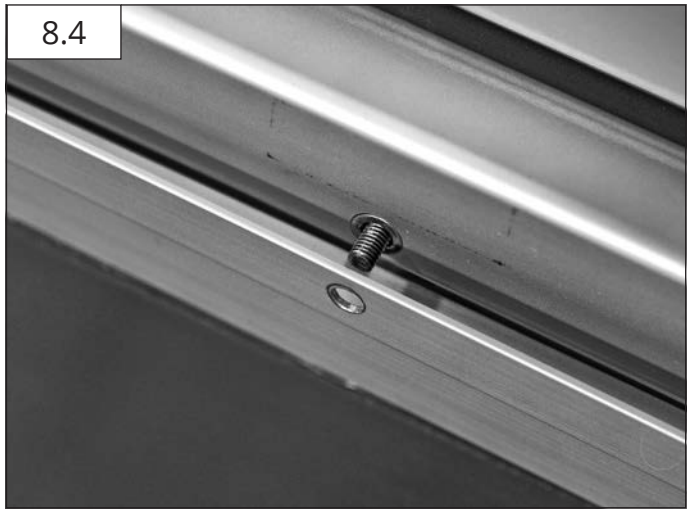

# 11 MONTERING SKJUTDÖRR

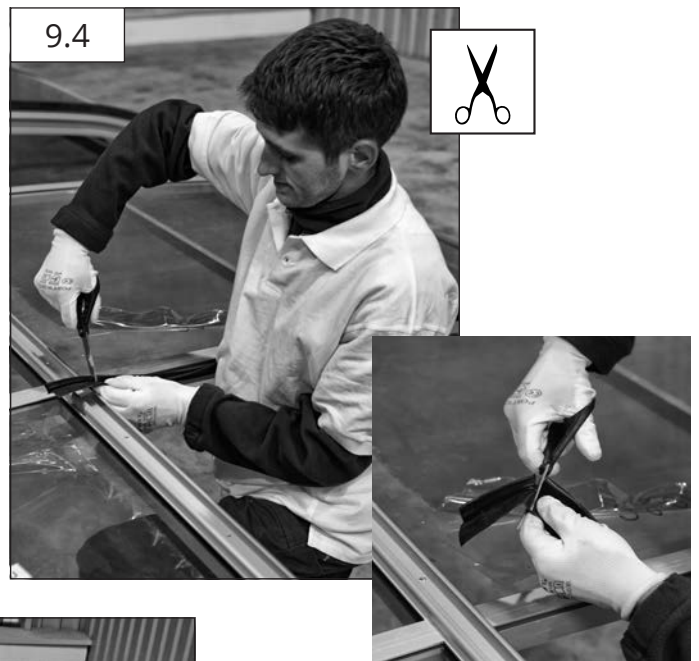
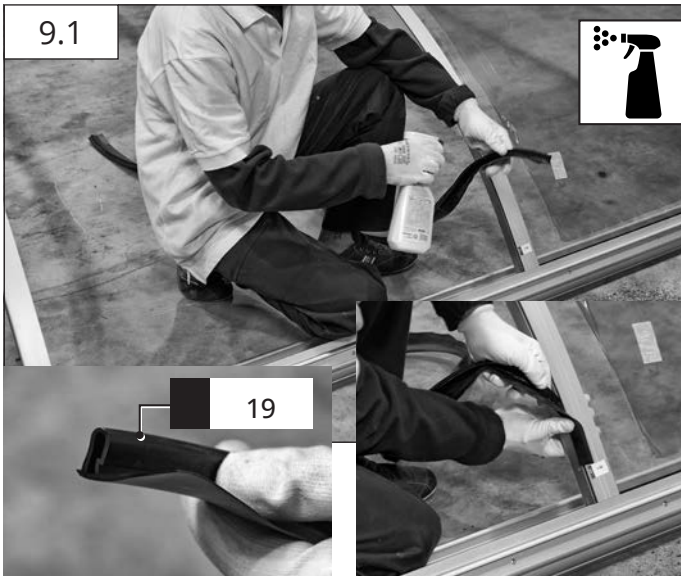

# 11 MONTERING SKJUTDÖRR

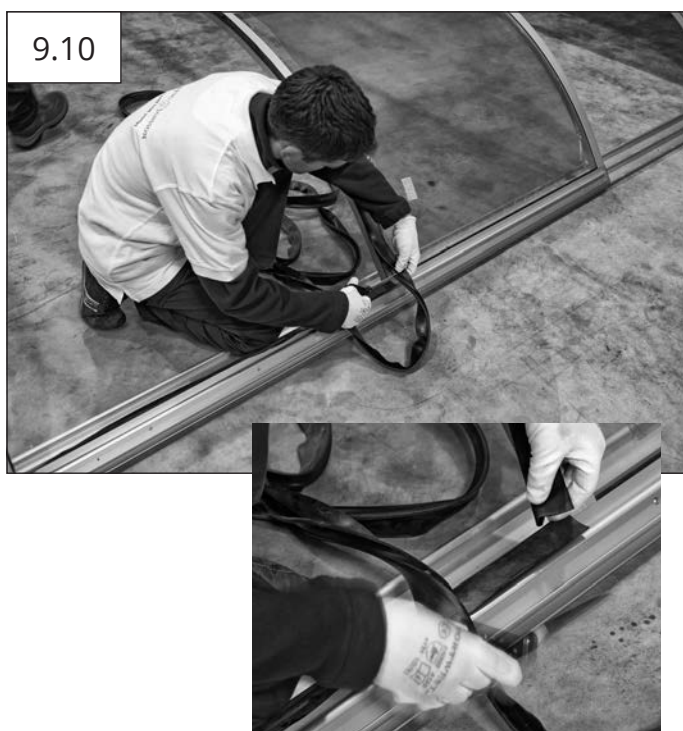
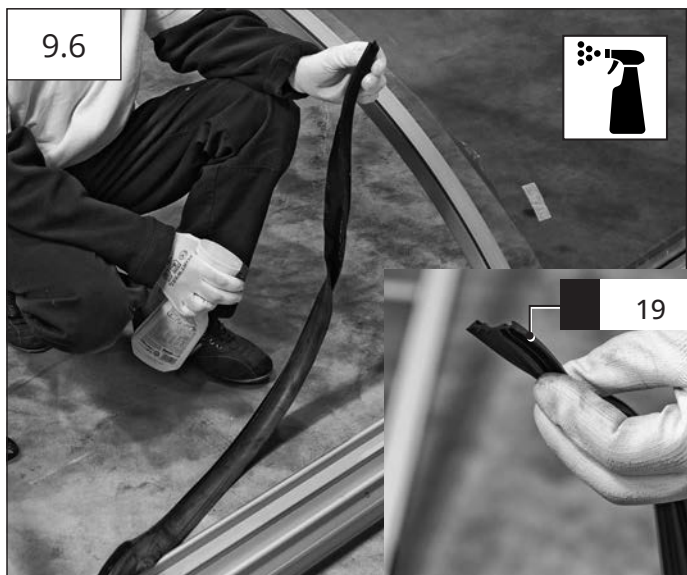

# 11 MONTERING SKJUTDÖRR

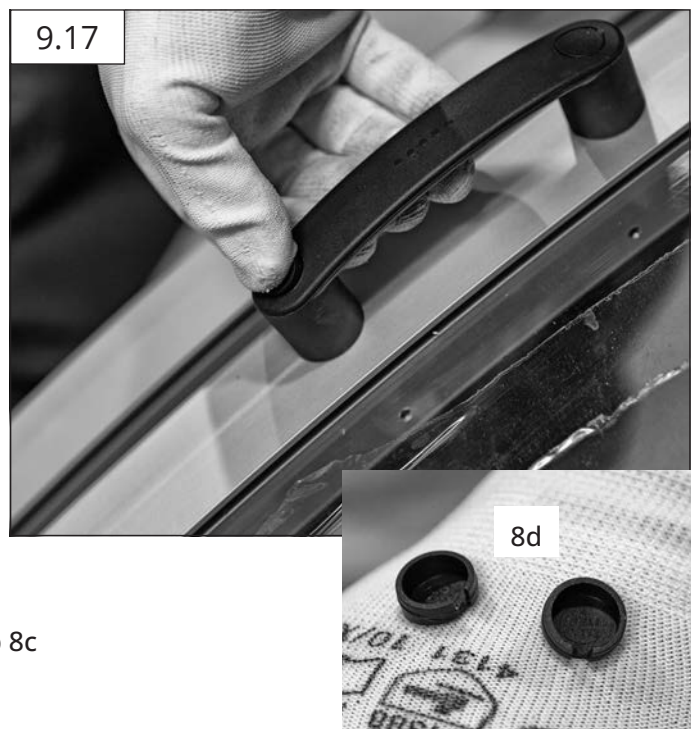
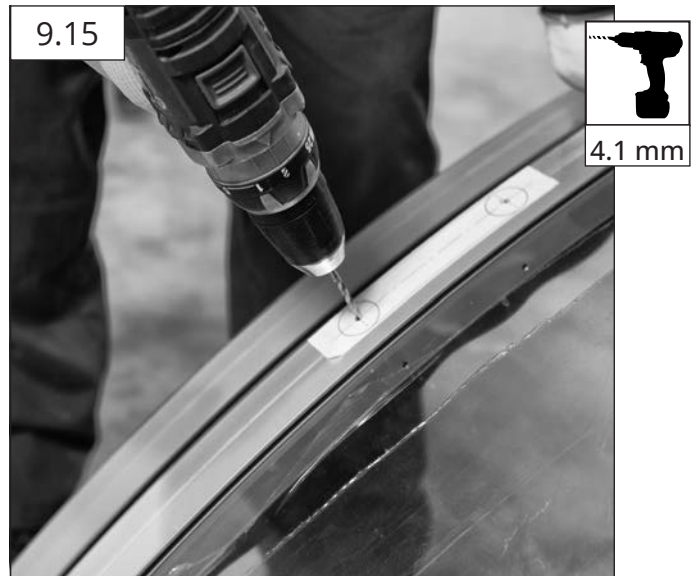
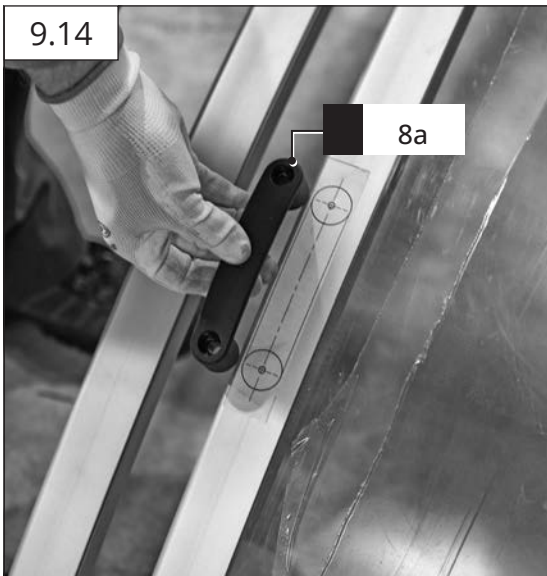
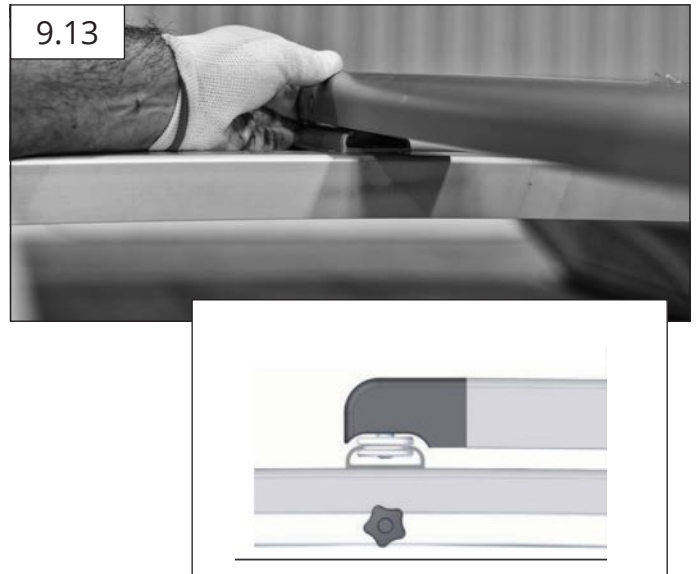

# 11 MONTERING SKJUTDÖRR

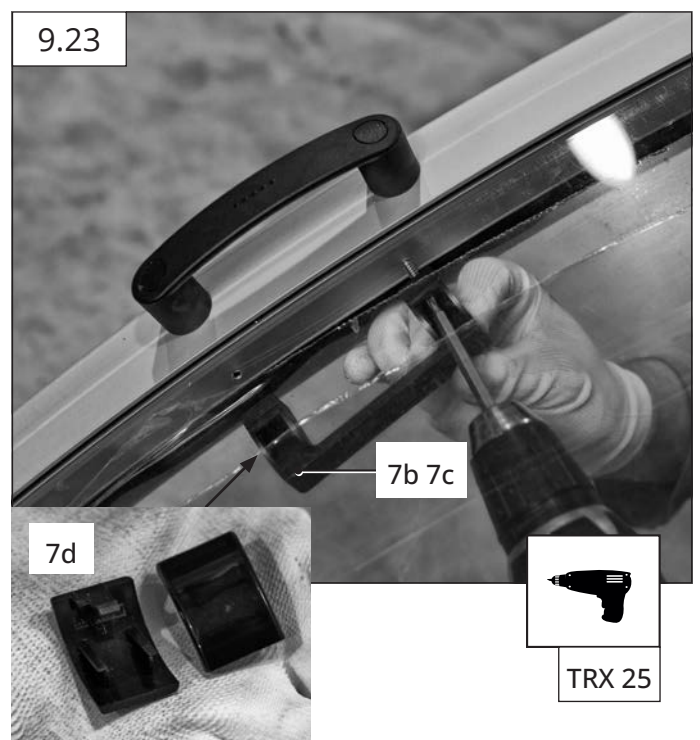
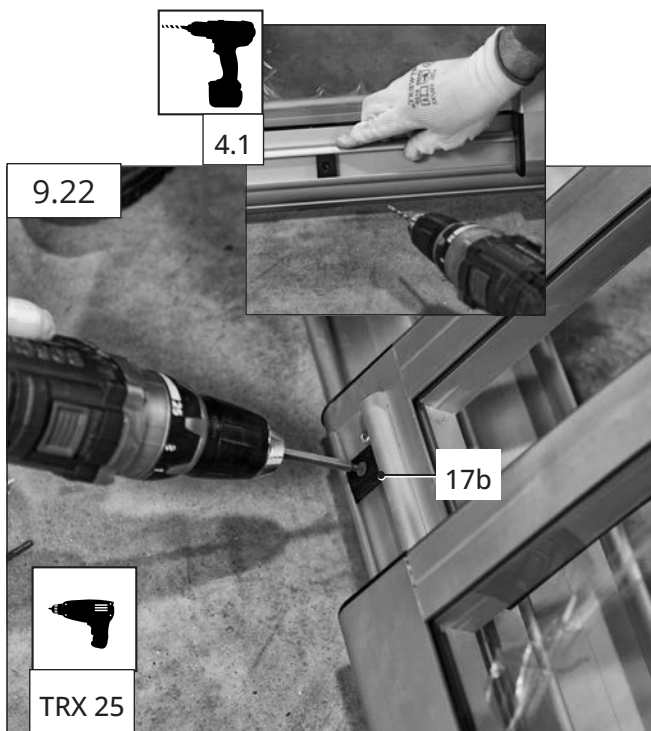
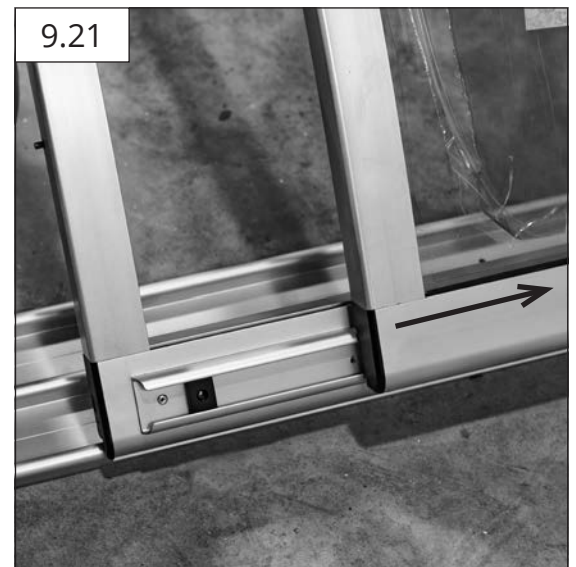
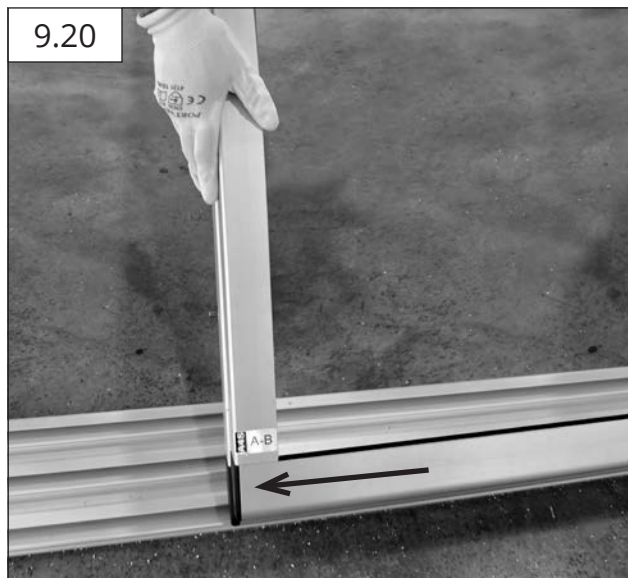
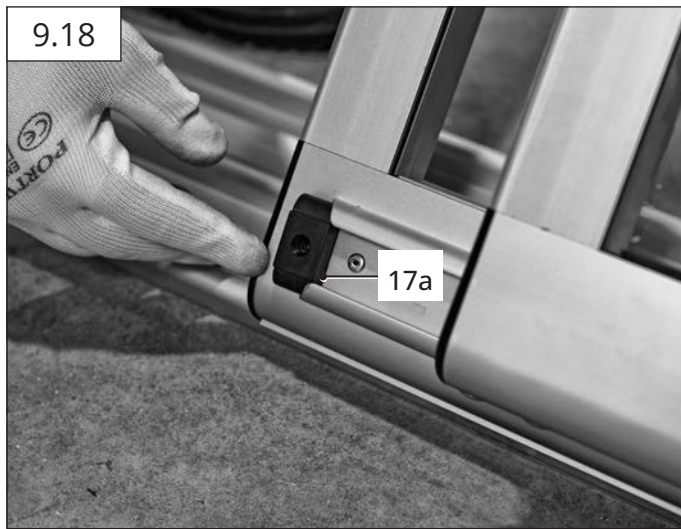

# 11 MONTERING SKJUTDÖRR

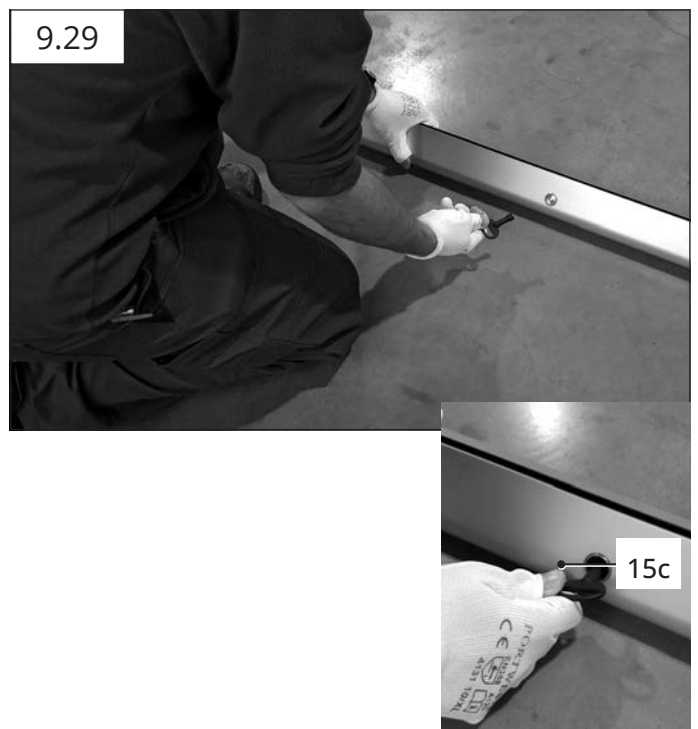
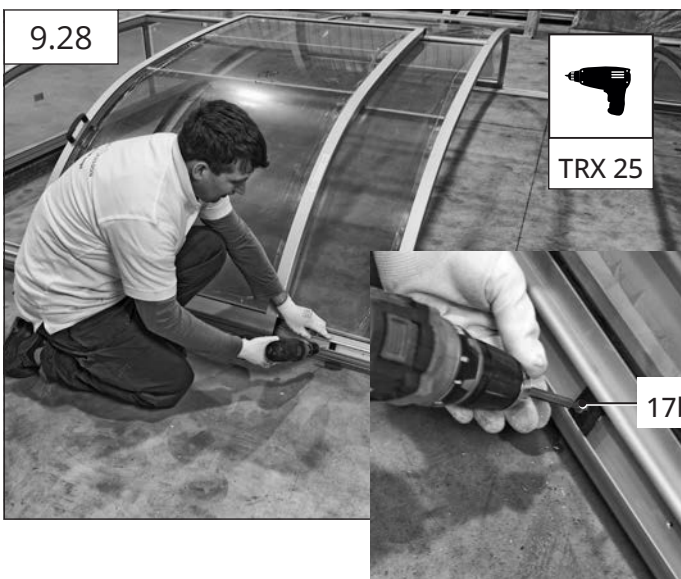
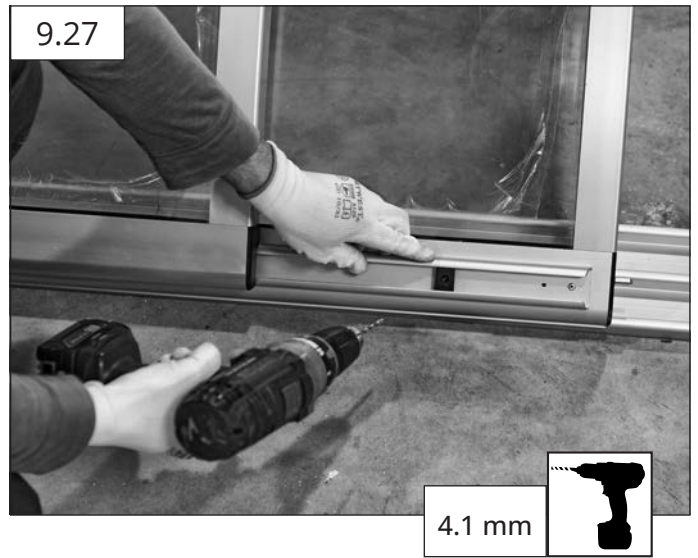

# 1 SLUTMONTERING

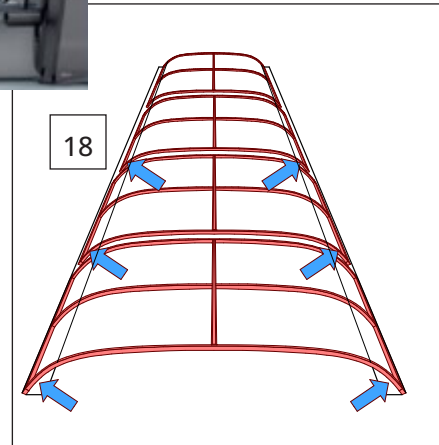
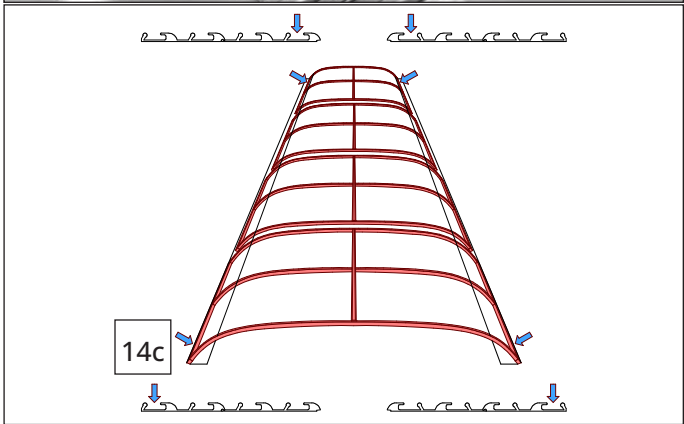
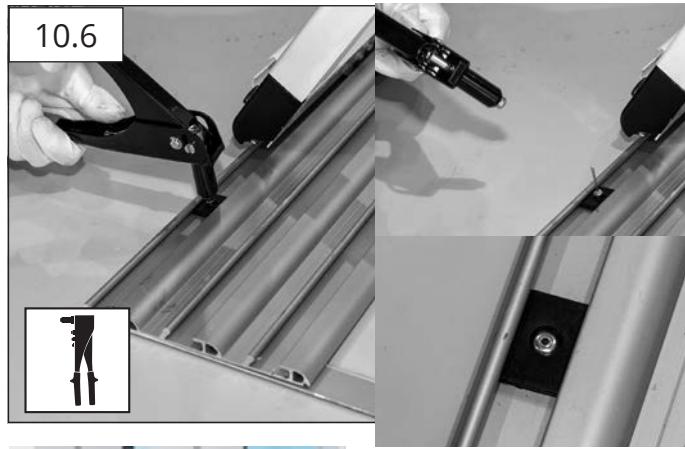
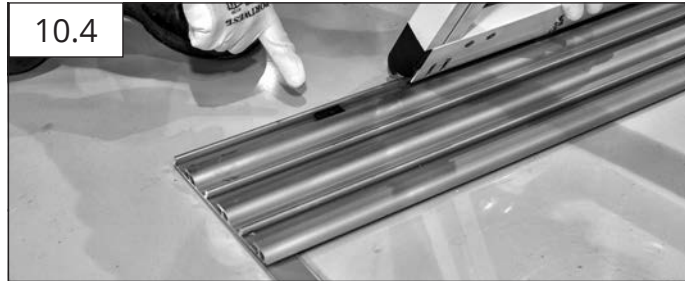
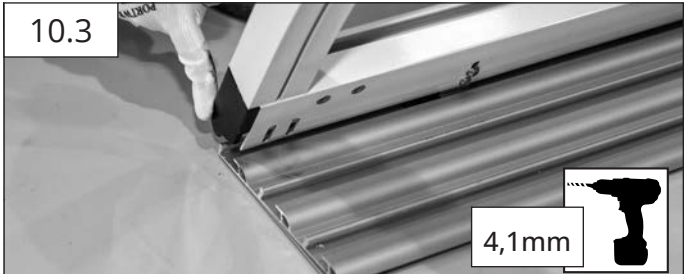
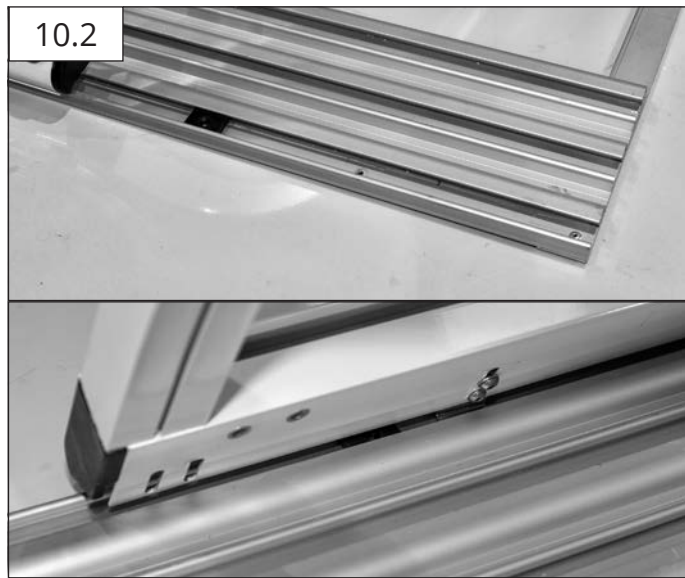
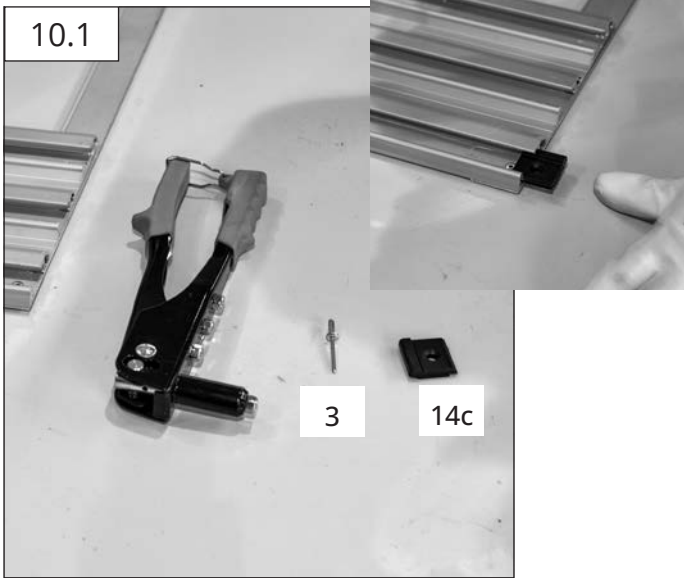

# 1 SLUTMONTERING

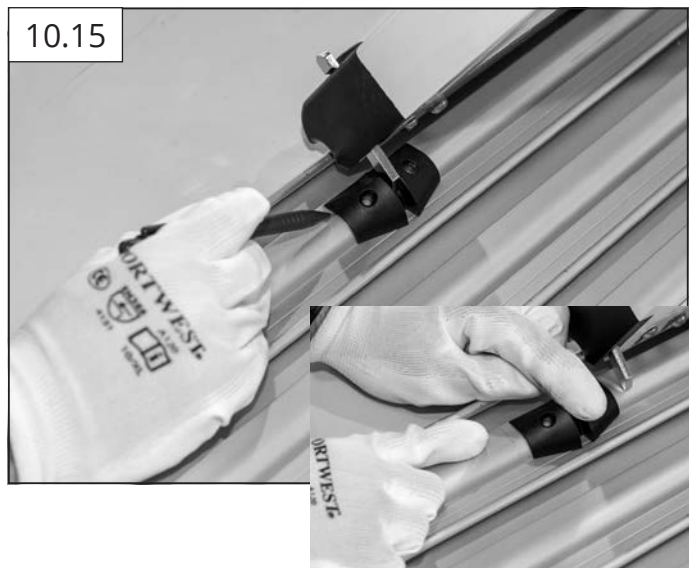
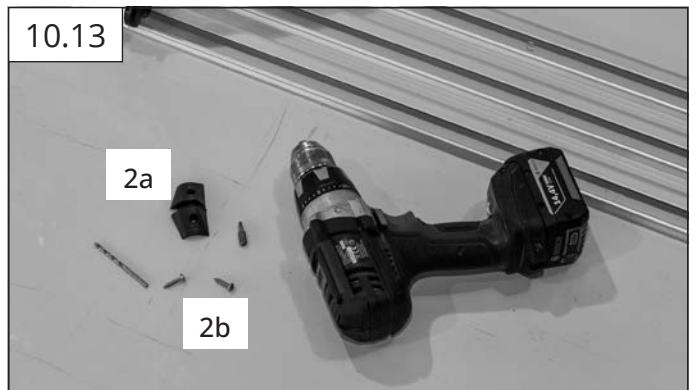
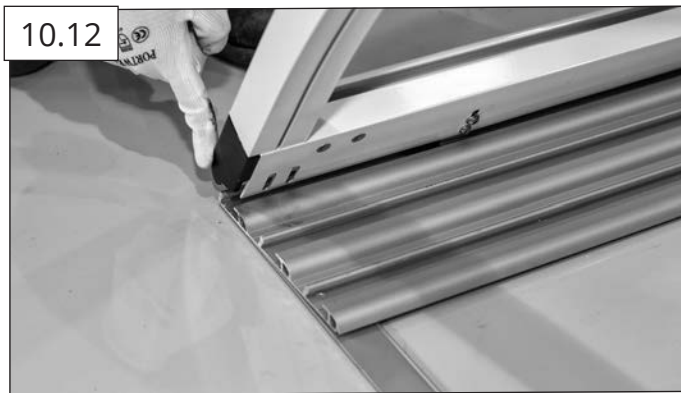
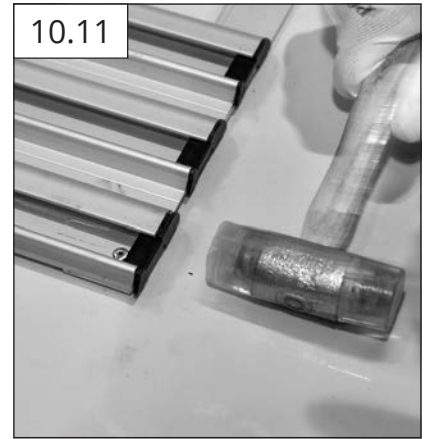
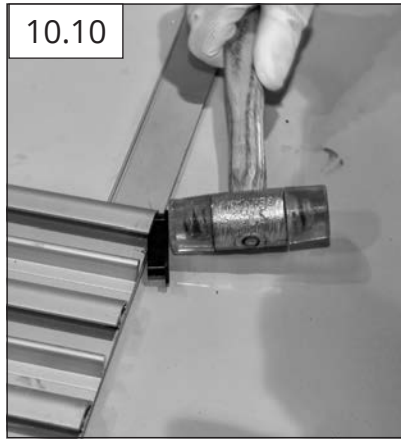
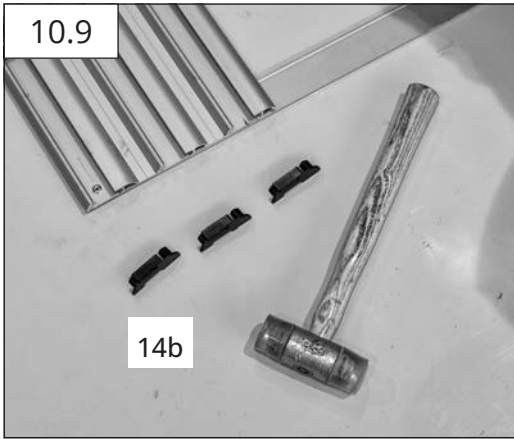
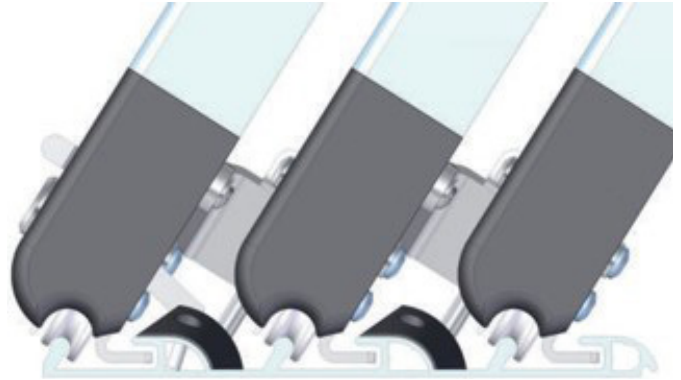

# 1 SLUTMONTERING

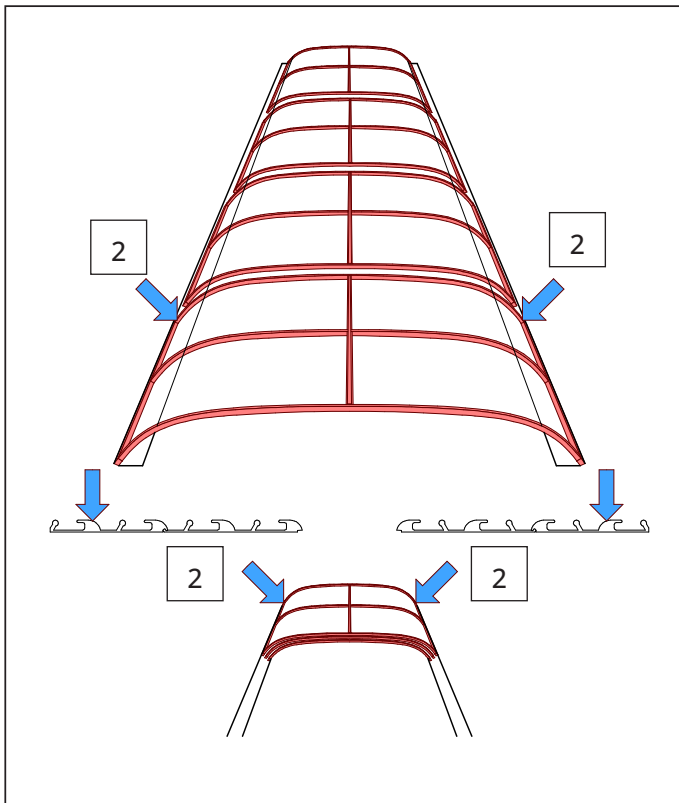
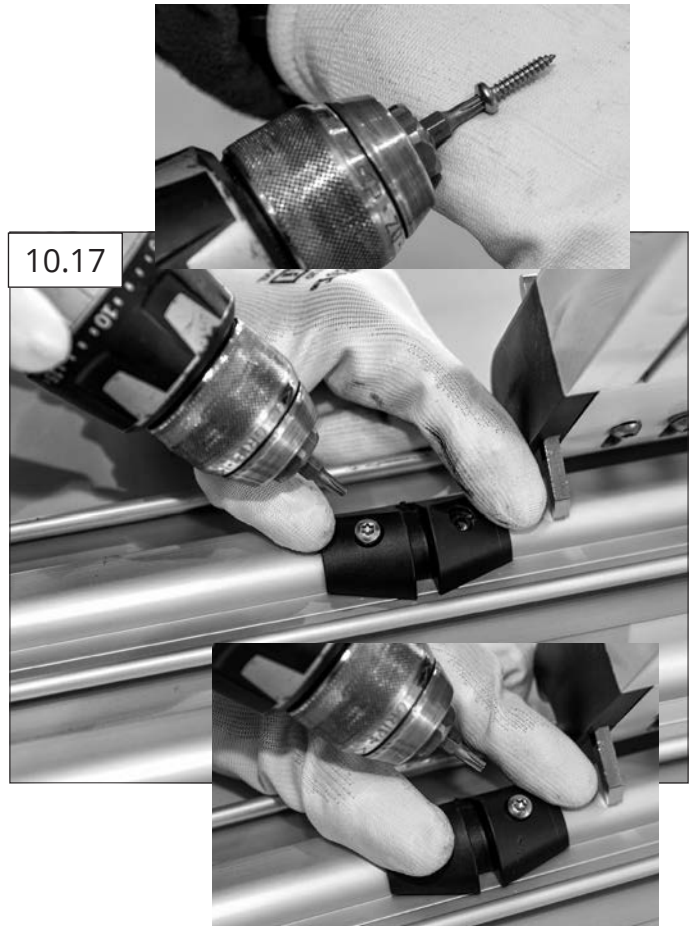

# 1 SLUTMONTERING

